

# DVR Series

---

Version 1.3.5



User Manual

Please read these instructions carefully before operating the unit and keep for further reference.

# Notes

- Please read this user manual carefully to ensure that you can use the device correctly and safely.
- There may be several technically incorrect places or printing errors in this manual. The updates will be added into the new version of this manual. The contents of this manual are subject to change without notice.
- This device should be operated only from the type of power source indicated on the marking label. The voltage of the power must be verified before using the same. Kindly remove the cables from the power source if the device is not to be used for a long period of time.
- Do not install this device near any heat sources such as radiators, heat registers, stoves or other devices that produce heat.
- Do not install this device near water. Clean only with a dry cloth.
- Do not block any ventilation openings and ensure proper ventilation around the machine.
- Do not power off the device at normal recording condition.
- This machine is for indoor use only. Do not expose the machine in rain or moist environment. In case any solid or liquid get inside the machine's case, please turn off the device immediately and get it checked by a qualified technician.
- Do not try to repair the device by yourself without technical aid or approval.
- When this product is in use, the relevant contents of Microsoft, Apple and Google will be involved in. The pictures and screenshots in this manual are only used to explain the usage of our product. The ownerships of trademarks, logos and other intellectual properties related to Microsoft, Apple and Google shall belong to the above-mentioned companies.
- It is recommended to back up and clear the personal data stored in the device before the device is returned to us for repair or replacement except those data that are essential for purposes of repair or replacement. The device will be restored to the default factory settings and all personal data will be cleared after repair or replacement. Our company ensures that the customer's data is not made available to third parties if the device is exchanged.
- This manual is suitable for many models. All examples and pictures used in the manual are from one of the models for reference purpose.
- The local language versions of this manual will be provided to users in the corresponding regions and countries.

## Disclaimer

- With regard to the product with internet access, the use of product shall be wholly at your own risks. Our company shall be irresponsible for abnormal operation, privacy leakage or other damages resulting from cyber attack, hacker attack, virus inspection, or other internet security risks; however, our company will provide timely technical support if necessary.
- Surveillance laws vary from country to country. Check all laws in your local region before using this product for surveillance purposes. We shall not take the responsibility for any

consequences resulting from illegal operations.

- The storage period of the personal data depends on the capacity of the storage devices the users use and all data stored in the device shall be handled by themselves. Our company shall not be responsible for the data loss.

## Cybersecurity Recommendations

- Change passwords and use strong passwords. At least 8 characters or a combination of characters, numbers, and upper and lower case letters should be used in your password.
- The system will automatically check the latest firmware version once a day. Once the latest version is checked, you'd better update it to ensure the system is current with the latest security patches and fixes.
- Regularly change the passwords of your devices to ensure that only authorized users can access the system.
- Change default ports (like HTTP, data port) to reduce the risk of outsiders being able to access.
- It is recommended to set the firewall of your router. But note that some important ports cannot be closed (like 80, 443, 6036).

## Regulatory Information

### FCC Marking



The products have been tested and found in compliance with the council FCC rules and regulations part 15 subpart B. Operation of this product is subject to the following two conditions: (1) this device may not cause harmful interference, and (2) this device must accept any interference received, including interference that may cause undesired operation.

### CE Marking



The products have been manufactured to comply with the following directives.  
EMC Directive 2014/30/EU

### RoHS Marking

The products have been designed and manufactured in accordance with Directive EU RoHS Directive 2011/65/EU and its amendment Directive EU 2015/863 on the restriction of the use of certain hazardous substances in electrical and electronic equipment.

# Contents

<b>Contents .....</b>	<b>i</b>
<b>1 Introduction .....</b>	<b>1</b>
1.1 Summary .....	1
1.2 Features .....	1
1.3 Front Panel Descriptions .....	4
1.4 Rear Panel Descriptions .....	5
1.5 Connections .....	7
<b>2 Basic Operation Guide .....</b>	<b>10</b>
2.1 Startup & Shutdown .....	10
2.1.1 Startup .....	10
2.1.2 Shutdown .....	10
2.2 Remote Controller .....	10
2.3 Mouse Control .....	12
2.4 Text-input Instruction .....	12
2.5 Common Button Operation .....	13
<b>3 Wizard &amp; Main Interface .....</b>	<b>14</b>
3.1 Startup Wizard .....	14
3.2 Main Interface .....	18
3.2.1 Main Interface Introduction .....	18
3.2.2 Setup Panel .....	20
3.2.3 Main Functions .....	21
<b>4 Camera Management .....</b>	<b>23</b>
4.1 Camera Signal .....	23
4.2 Add/Edit Camera .....	23
4.2.1 Add Camera .....	23
4.2.2 Edit Camera .....	25
<b>5 Live View Introduction .....</b>	<b>26</b>
5.1 Live View Interface Introduction .....	26
5.2 View Mode .....	27
5.2.1 Display Mode .....	27
5.2.2 Quick Sequence View .....	28
5.2.3 Scheme View In Sequence .....	29
5.2.4 Spot View .....	30
5.3 POS Settings .....	31
5.4 Image Configuration .....	33
5.4.1 OSD Settings .....	33
5.4.2 Image Settings .....	34
5.4.3 Mask Settings .....	34
5.4.4 Water Mark Settings .....	35
5.4.5 Image Adjustment .....	36
<b>6 PTZ .....</b>	<b>38</b>
6.1 PTZ Control Interface Introduction .....	38

6.2 Preset Setting.....	42
6.3 Cruise Setting.....	43
6.4 PTZ Protocol Setting.....	44
<b>7 Record &amp; Disk Management .....</b>	<b>45</b>
7.1 Record Configuration.....	45
7.1.1 Mode Configuration.....	45
7.1.2 Advanced Configuration.....	47
7.2 Encode Parameters Setting.....	47
7.3 Schedule Setting.....	48
7.3.1 Add Schedule.....	48
7.3.2 Record Schedule Configuration.....	51
7.4 Record Mode.....	51
7.4.1 Manual Recording.....	51
7.4.2 Timing Recording.....	51
7.4.3 Motion Based Recording.....	51
7.4.4 Sensor Based Recording.....	52
7.4.5 Intelligence Recording.....	52
7.5 Disk Management.....	52
7.5.1 Storage Mode Configuration.....	52
7.5.2 View Disk and S.M.A.R.T. Information.....	53
<b>8 Playback &amp; Backup.....</b>	<b>55</b>
8.1 Instant Playback.....	55
8.2 Playback Interface Introduction.....	55
8.3 Smart Playback.....	58
8.4 Record Search, Playback & Backup.....	60
8.4.1 Search, Playback & Backup by Time-sliced Image.....	60
8.4.2 Smart Search.....	62
8.4.3 Search, Playback & Backup by Time.....	63
8.4.4 Search, Playback & Backup by Event.....	64
8.4.5 Search & Playback by Tag.....	65
8.4.6 Image Management.....	65
8.4.7 View Backup Status.....	66
<b>9 Alarm Management .....</b>	<b>67</b>
9.1 Sensor Alarm.....	67
9.2 Motion Alarm.....	68
9.2.1 Motion Configuration.....	68
9.2.2 Motion Alarm Handling Configuration.....	69
9.3 Intelligence Alarm.....	69
9.3.1 Object Detection.....	69
9.3.2 Exception.....	71
9.3.3 Tripwire.....	72
9.3.4 Intrusion Detection.....	73
9.4 Exception Alarm.....	75
9.4.1 IPC Offline Settings.....	75
9.4.2 Video Loss Settings.....	76
9.4.3 Exception Handling Settings.....	76
9.5 Alarm Event Notification.....	77

9.5.1 Alarm-out .....	77
9.5.2 E-mail .....	77
9.5.3 Display .....	77
9.5.4 Buzzer .....	78
9.5.5 Push Message .....	78
9.5.6 Alarm Server .....	78
9.6 Manual Alarm .....	79
9.7 View Alarm Status .....	79
<b>10 Account &amp; Permission Management .....</b>	<b>81</b>
10.1 Account Management .....	81
10.1.1 Add User .....	81
10.1.2 Edit User .....	82
10.2 User Login & Logout .....	84
10.3 Permission Management .....	84
10.3.1 Add Permission Group .....	84
10.3.2 Edit Permission Group .....	85
10.4 Black and White List .....	85
10.5 Preview On Logout .....	86
10.6 Password Security .....	87
10.7 View Online User .....	87
<b>11 Device Management .....</b>	<b>88</b>
11.1 Network Configuration .....	88
11.1.1 TCP/IP Configuration .....	88
11.1.2 Port Configuration .....	88
11.1.3 PPPoE Configuration .....	90
11.1.4 DDNS Configuration .....	90
11.1.5 E-mail Configuration .....	93
11.1.6 UPnP Configuration .....	94
11.1.7 NAT Configuration .....	95
11.1.8 802.1X .....	95
11.1.9 FTP Configuration .....	96
11.1.10 Platform Access .....	96
11.1.11 3G/4G (Optional) .....	96
11.1.12 Wi-Fi (Optional) .....	97
11.1.13 SNMP (Optional) .....	98
11.1.14 View Network Status .....	99
11.2 Basic Configuration .....	99
11.2.1 Common Configuration .....	99
11.2.2 Date and Time Configuration .....	100
11.2.3 Recorder OSD Settings .....	101
11.3 Factory Default .....	101
11.4 Device Software Upgrade .....	101
11.5 Backup and Restore .....	102
11.6 Restart Automatically .....	102
11.7 View Log .....	103
11.8 View System Information .....	103
<b>12 Remote Surveillance .....</b>	<b>105</b>

---

12.1 Mobile Client Surveillance.....	105
12.2 Web LAN Access .....	105
12.3 Web WAN Access.....	106
12.4 Web Remote Control.....	107
12.4.1 Remote Preview .....	108
12.4.2 Remote Playback.....	111
12.4.3 Remote Backup .....	112
12.4.4 Remote Configuration .....	112
<b>Appendix A FAQ.....</b>	<b>113</b>
<b>Appendix B Calculate Recording Capacity .....</b>	<b>118</b>
<b>Appendix C Compatible Device List .....</b>	<b>119</b>

# 1 Introduction

## 1.1 Summary

Based on the most advanced SOC technology and embedded system in the field, our DVRs adopt the new designed human interface and support the smart management of analog cameras and IP cameras and the record search of slice. The DVRs are powerful and easy to use and provide excellent image quality and stable system. They are the centralized monitoring management products with high performance and high quality specially designed for video monitoring field.

Therefore, the DVRs can be widely used to security system of banks at home and abroad, schools, intelligent mansions, traffic, environmental protection, supermarkets, petrol service stations, residential quarters and factories and so on.

## 1.2 Features

### Basic Functions

- Support local device and network device access including IP camera/dome and the third party IP cameras
- Support standard ONVIF protocol
- Support dual stream recording of each camera
- Support IP cameras to be added quickly or manually
- Support collective or individual configuration of the cameras' OSD, video parameters, mask, motion and so on
- Support a maximum of 8 user permission groups including Administrator, Advanced and Ordinary which are the default permission groups of the system
- Support a maximum of 16 users to be created, multiple web clients login by using one username at the same time and the user's permission control to be enabled or disabled
- Support a maximum of 10 web clients login at the same time

### Live View

- Support 4K×2K/2560×1440/1920×1080/1280×1024 HDMI and 1920×1080/1280×1024 VGA high definition synchronous display
- Support multi-screen modes
- Support auto adjustment of the camera's image display proportion
- Support audio monitoring of the camera to be enabled or disabled
- Support manual snap of the preview camera
- Support the sequence of the preview cameras to be adjusted
- Support display mode to be added and saved and the saved modes can be called directly
- Support quick tool bar operation of the preview window
- Support motion detection and video mask
- Support multiple popular P.T.Z. control protocol and setup of the preset and cruise
- Support direct mouse control of the dome including rotating, zoom, focusing and so on
- Support single camera image to be zoomed by sliding the scroll wheel of the mouse
- Support any area of the image to be zoomed in to a maximum of 16 times of the current



size

- Support image and lens adjustment (only available for some cameras)
- Support quick camera adding in the camera window of the live view interface
- The live camera sequence of the web client will keep consistent with that of the DVR after adjusting the live camera sequence of the DVR, but the live camera sequence of the DVR will not be changed if that of the web client is changed

#### **Disk Management**

- The DVRs with the 2U case can add a maximum of 8 SATA HDDs; a maximum of 4 SATA HDDs with the 1.5U case, a maximum of 2 SATA HDDs with the 1U case and a maximum of 1 SATA HDD with the small 1U case
- Each SATA interface of the DVR supports the HDDs with max 8TB storage capacity
- Support disk group configuration and management and each camera can be added into different disk groups with different storage capacity
- Support disk information and disk working status viewing
- Support batch formatting of the disks

#### **Record Configuration**

- Support main stream and sub stream recording at the same time and collective or individual configuration of the record stream
- Support manual and auto record modes
- Support schedule recording, sensor alarm recording and motion detection recording, etc
- Support schedule recording and event recording setting with different record streams
- Support record schedule setting and recycle recording
- Support pre recording and delay recording configuration of the event recording

#### **Record Playback**

- Support time scale operation in quick playback and the playback date and time can be set randomly by scrolling the mouse; the time interval of the time scale can be zoomed
- Support record searching by time slice/time/event/tag
- Support smart search and playback
- Support time view and camera view in searching by time slice mode
- Support time slice searching by month, by day, by hour and by minute and time slice to be displayed with camera thumbnail
- Support event searching by manual/motion/sensor/intelligent events
- Support tag searching by the manual added tags
- Support instant playback of the selected camera in the live view interface
- Support acceleration(maximum 32 times of the normal speed), deceleration (minimum 1/32 times of the normal speed) and 30s' addition or reduction to current playing time

#### **Record Backup**

- Support record to be backed up through USB (U disk, mobile HDD) interface
- Support record to be backed up by time/event/image searching
- Support record cutting for backing up when playing back
- Support a maximum of 10 backup tasks in background and backup status viewing

### Alarm Management

- Support alarm schedule setting
- Support enabling or disabling of the motion detection, external sensor alarm input, intelligence alarm and exception alarms including IP address conflict alarm, disk IO error alarm, disk full alarm, no disk alarm, illegal access alarm, network disconnection alarm, IPC offline alarm and so on, alarm trigger configuration supportable
- Support IPC offline alarm trigger configuration of PTZ, snap, pop-up video, etc.
- Support event notification modes of alarm-out, pop-up video, pop-up message box, buzzer, e-mail and so on
- The snapped images can be attached into the e-mail when alarm linkage is triggered
- Support alarm status view of alarm-in, alarm-out, motion detection and exception alarm
- Support alarm to be triggered and cleared manually
- Support system auto reboot when exception happens

### Network Functions

- Support TCP/IP and PPPoE, DHCP, DNS, DDNS, UPnP, NTP, SMTP protocol and so on
- Support black and white list function and the black and white IP address/IP segment/MAC address can be set
- Support multiple browsers including IE8/9/10/11, Firefox, Opera, Chrome (available only for the versions lower than 45) and Safari in MAC system
- Support remote achievement, configuration, import and export of the DVR parameters and other system maintenance operations including remote upgrading and system restart
- Support remote camera configuration of the DVR including video parameters, image quality and so on
- Support remote searching, playback and backup of the DVR
- Support manual alarm to be triggered and cleared remotely
- The auto-focusing camera can be adjusted through web client (support zoom in/out, but one key focus is not currently supported)
- Support NVMS or other platform management software to access the DVR and manage it
- Support NAT function and QRCode scanning by mobile phone and tablet
- Support mobile surveillance by phones or tablets with iOS or Android OS
- Support DVR to be accessed remotely through telnet and the telnet function can be enabled or disabled
- If one camera recording is enabled or disabled manually through web client, it will be simultaneously enabled or disabled in the DVR

### Other Functions

- The DVR can be controlled and operated by the buttons on the front panel, the remote controller and the mouse
- Setting interfaces can be switched to one another conveniently by clicking the main menus on the top of the setting interfaces
- Support DVR information viewing including basic, camera status, alarm status, record status, network status, disk and backup status
- Support factory restoring, import and export of the system configuration, log view and

export and local upgrading by USB mobile device

- Support auto recognition of the displayer's resolution
- You can click the right mouse button at any interface to go back to the upper interface
- You can click the middle mouse button at any interface to go to the live view interface
- The display language and video format of the DVR will not be changed and the system logs will be reserved if you reset the DVR to factory default
- Press and hold the right mouse button for 5 seconds in any interface to switch the output to VGA and the DVR will display the video at the lowest resolution which the DVR supports





## 1.3 Front Panel Descriptions

The following descriptions are for reference only.

Type I:

Name	Descriptions
REC	When recording, the light is blue
Net	When access to network , the light is blue
Power	Power indicator, when the device is powered , the light is blue
Fn	No function temporarily

Type II:

Name	Descriptions
Power	Power Indicator, when connected, the light is blue
HDD	The light turns blue when reading/writing HDD
Net	The light turns blue when it is able to access the network
Backup	The light turns blue when backing up files and data
Play	The light turns blue when playing video
REC	Power Indicator, when the device is connected, the light is blue
AUDIO /+	1. Adjust audio 2. Increase the value in setup
PT.Z /-	1. Enter PTZ mode 2. Decrease the value in setup
MENU	Enter Menu in live
INFO	Check the information of the device
BACKUP	Enter backup mode in live
SEARCH	Enter search mode in live
Exit	Exit the current interface
	Manually record
	Play/Pause
	Speed down
	Speed up
1-9	Input digital number and select camera
0/--	Input number 0, the number above 10
Direction Key	Change direction

Name	Descriptions
Multi-Screen Switch	Change the screen mode
Enter	Confirm selection
USB	To connect external USB device like USB mouse or USB flash

## 1.4 Rear Panel Descriptions

Here we only take a part of real panels for example to introduce their interfaces and connections. The interfaces and locations of the interfaces are only for references. Please take the real object as the standard.

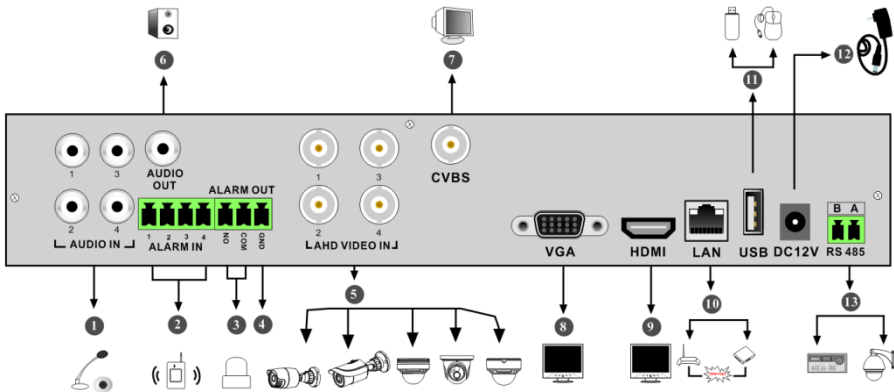

No.	Name	Descriptions
1	AUDIO IN	Audio input
2	ALARM IN	Alarm inputs for connecting sensors
3	ALARM OUT	Relay output; connect to external alarms
4	GND	Ground
5	AHD VIDEO IN	4 CH AHD video inputs
6	AUDIO OUT	Audio output
7	CVBS	CVBS video output; connect to monitor
8	VGA	Connect to monitor
9	HDMI	Connect to high definition display devices
10	LAN	Network port
11	USB	Connector for USB storage devices or USB mouse
12	DC12V	DC12V power input
13	RS485	Connector for keyboards or speed domes. A is TX+; B is TX-

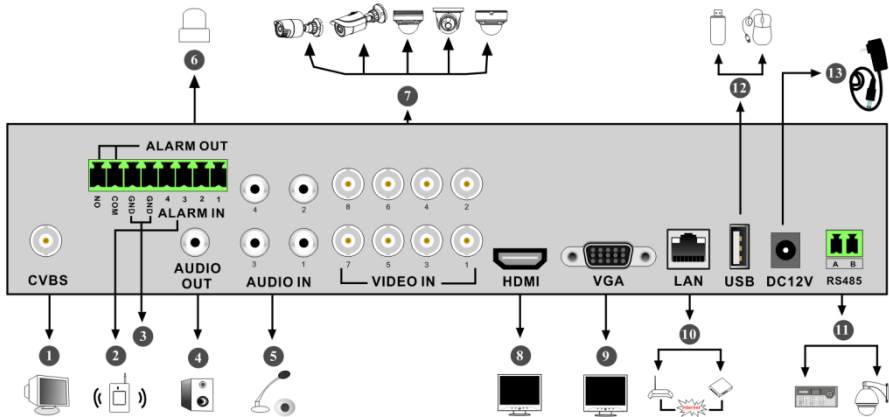

No.	Name	Descriptions
1	CVBS	CVBS video output; connect to monitor
2	ALARM IN	Alarm inputs for connecting sensors
3	GND	Ground
4	AUDIO OUT	Audio output; connect to sound box
5	AUDIO IN	Audio input
6	ALARM OUT	Relay output; connect to external alarms
7	VIDEO IN	8 CH video inputs
8	HDMI	Connect to high definition display devices
9	VGA	Connect to monitor
10	LAN	Network port
11	RS485	Connectors for keyboards or speed domes. A is TX+; B is TX-
12	USB	Connector for USB storage devices or USB mouse
13	DC12V	DC12V power input

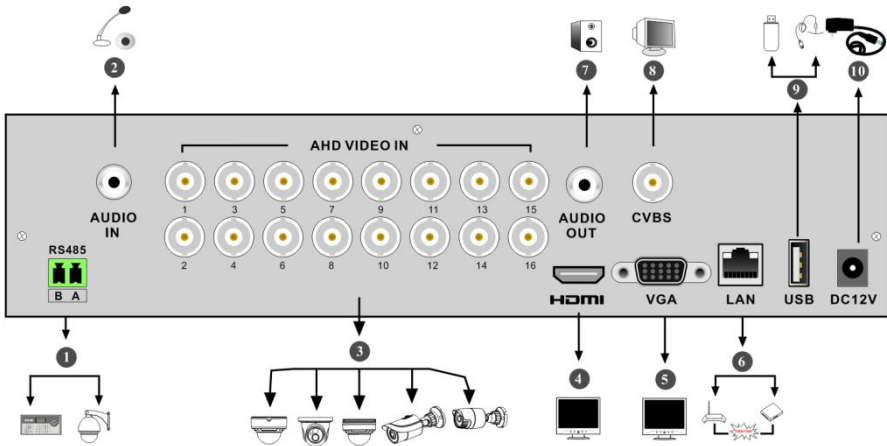

No.	Name	Descriptions
1	RS485	Connectors for keyboards or speed domes. A is TX+; B is TX-
2	AUDIO IN	Audio input
3	AHD VIDEO IN	16 CH AHD video inputs
4	HDMI	Connect to monitor
5	VGA	Connect to monitor
6	LAN	Network port
7	AUDIO OUT	Audio output
8	CVBS	CVBS video output; connect to monitor
9	USB	Connect USB storage devices or USB mouse
10	DC12V	DC12V power input

## 1.5 Connections

### ● Video Connections

Video Output: Supports VGA/HDMI video output. You can connect to monitor through these video output interfaces simultaneously or independently.

### ● Audio Connections

Audio Input: Connect to microphone, pickup, etc.

Audio Output: Connect to headphone, sound box or other audio output devices.

### ● Alarm Connections

Some models may support this function. Take 16 CH alarm inputs and 1 CH alarm output for example.

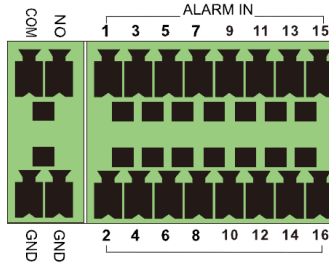

**Alarm Input:**

Alarm IN 1~16 are 16 CH alarm input interfaces. There are no type requirements for sensors. NO type and NC type are both available.

The way to connect sensor and the device is as shown below:



The alarm input is an open/closed relay. If the input is not an open/closed relay, please refer to the following connection diagram:

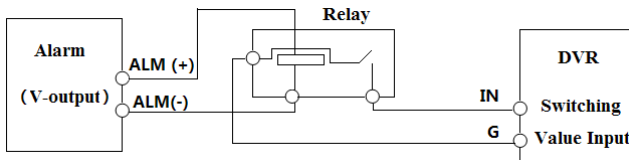

**Alarm Output:**

The way to connect alarm output device:

Pull out the green terminal blocks and loosen the screws in the alarm-out port. Then insert the signal wires of the alarm output devices into the port of NO and COM separately. Finally, tighten the screws. Provided that the external alarm output devices need power supply, you can connect the power supply as per the following figures.

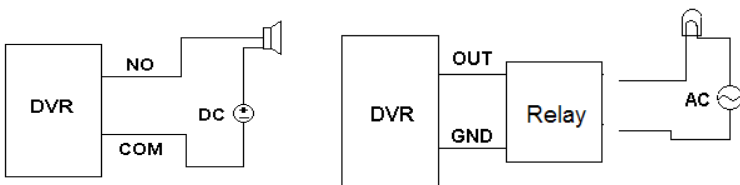

- **RS485 Connection**

There are two types of RS485 interfaces:

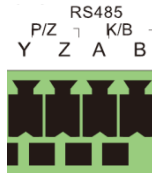

( Type 1 )



( Type 2 )

Type 1: The P/Z interfaces are used to connect speed dome. K/B interfaces are used to connect keyboard.

Type 2: The RS485 interfaces are not only used to connect speed dome but also to connect keyboard.

The way to connect speed dome to the DVR:

Type 1: Disconnect pluggable block from the RS485 terminal block and then loosen the fixed screws from the pluggable block, insert signal cables into Y and Z port separately (Y is TX+; Z is TX-) and tighten the fixed screws. Next, connect pluggable block back into terminal block. Finally, connect the video cable of the speed dome to the video input interface of the DVR.

Type 2: Disconnect pluggable block from the RS485 terminal block and then loosen the fixed screws from the pluggable block, insert signal cables into A and B port separately (A is TX+; B is TX-) and tighten the fixed screws. Next, connect pluggable block back into terminal block. Finally, connect the video cable of the speed dome to the video input interface of the DVR.

*Note:*

*The pluggable block of some models may not be connected into the terminal block and you shall obtain it from the accessories.*



## 2 Basic Operation Guide

### 2.1 Startup & Shutdown

Please make sure all the connections are done properly before you power on the unit. Proper startup and shutdown are crucial to extending the life of your device.

#### 2.1.1 Startup

- ① Connect the output display device to the VGA/HDMI interface of the DVR.
- ② Connect with the mouse and power. The device will boot and the power LED would turn blue.
- ③ A WIZARD window will pop up (you should select the display language the first time you use the DVR). Refer to [3.1 Startup Wizard](#) for details.

#### 2.1.2 Shutdown

You can power off the device by using remote controller or mouse.

##### By remote controller:

- ① Press Power button. This will take you to a shutdown window. The unit will power off after a while by clicking “OK” button.
- ② Disconnect the power.

##### By mouse:

- ① Click Start→Shutdown to pop up the Shutdown window. Select “Shutdown” in the window. The unit will power off after a while by clicking “OK” button.
- ② Disconnect the power.

### 2.2 Remote Controller

- ① It uses two AAA size batteries.
- ② Open the battery cover of the remote controller.
- ③ Place batteries. Please take care the polarity (+ and -).
- ④ Replace the battery cover.

Key points to check in case the remote doesn't work.

1. Check batteries polarity.
2. Check the remaining charge in the batteries.
3. Check IR controller sensor for any masking.

If it still doesn't work, please change a new remote controller to try, or contact your dealers. You can just turn the IR sensor of the remote controller towards the IR receiver of the DVR to control it when you are controlling multiple devices by remote controller.

There are two kinds of remote controller. The interface of remote controller is shown as below.

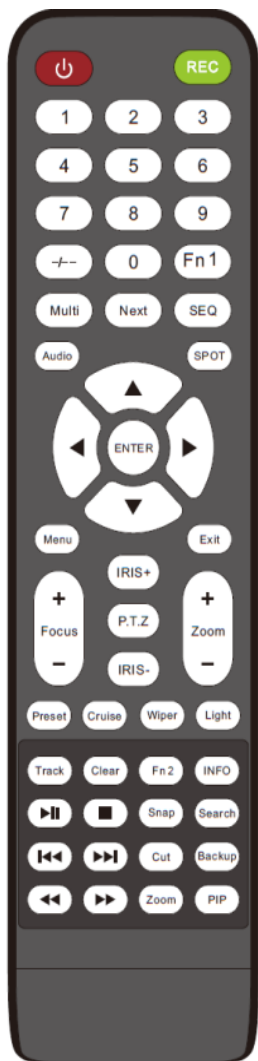

Button	Function
Power Button	Switch off—to stop the device
Record Button	To start recording
-/-- /0-9	Input number or choose camera
Fn1 Button	Unavailable temporarily
Multi Button	To choose multi screen display mode
Next Button	To switch the live image
SEQ	To go to sequence view mode
Audio	To enable audio output in live mode
Switch	No function temporarily
Direction button	To move cursor in setup or pan/title PTZ
Enter Button	To confirm the choice or setup
Menu Button	To go to menu
Exit Button	To exit the current interface
Focus/IRIS/Zoom/PTZ	To control PTZ camera
Preset Button	To enter into preset setting in PTZ mode
Cruise Button	To go to cruise setting in PTZ mode
Track Button	No track function temporarily
Wiper Button	No function temporarily
Light Button	No function temporarily
Clear Button	No function temporarily
Fn2 Button	No function temporarily
Info Button	Get information about the device
	To control playback. Play(Pause)/Stop/Previous Frame/Next Frame/Speed Down/Speed Up
Snap Button	To take snapshots manually
Search Button	To go to search mode
Cut Button	No function temporarily
Backup Button	To go to backup mode
Zoom Button	To zoom in the images
PIP Button	No function temporarily

**Note:**

You shall press P.T.Z button to enter PTZ setting mode, choose a channel and press P.T.Z button again to hide the P.T.Z control panel. Then you can press preset, cruise, track, wiper or light button to enable the relevant function.



Button	Function
REC	Record manually
Search	To enter search mode
MEUN	To enter menu
Exit	To exit the current interface
ENTER	To confirm the choice or setup
Direction button	To move cursor in setup
ZOOM	To zoom in
PIP	No function temporarily
	To control playback. Play(Pause)/Next Frame/Speed Up/Stop/Previous Frame/Speed Down
Multi	To choose multi screen display mode
Next	To switch the live image
SEQ	To go to sequence view mode
INFO	Get information about the device

## 2.3 Mouse Control

### ➤ Mouse control in Live Display & Playback interface

In the live display & playback interface, double click on any camera window to show the window in single screen mode; double click the window again to restore it to the previous size.

In the live display & playback interface, if the interfaces display in full screen, move the mouse to the bottom of the interface to pop up a tool bar. The tool bar will disappear automatically after you move the mouse away from it for some time; move the mouse to the right side of the interface to pop up a panel and the panel will disappear automatically after you move the mouse away from it.

### ➤ Mouse control in text-input





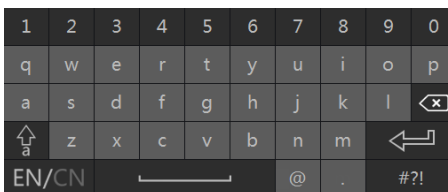
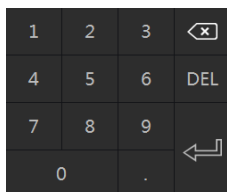

Move the mouse to the text-input box and then click the box. The input keyboard will pop up automatically.

*Note: Mouse is the default tool for all operations unless an exception as indicated.*







## 2.4 Text-input Instruction



The system includes two input boxes. Refer to the above pictures. The left box is the number input box and the right box is the input box which provides inputs of numbers, letters and punctuation characters. The introductions of keys on the input boxes are shown below.

Button	Meaning	Button	Meaning
	Backspace key		Switch key of punctuation character
	Delete Key		Enter key
	Switch key between upper and lower letter		Space key
	Switch key of language		

## 2.5 Common Button Operation

Button	Meaning
	Click it to show the menu list.
	Click it to change the sequence of the list.
	Click it to change the camera displaying mode.
	Click it to close the current interface.
	Click it to go to the earliest date of camera recording.
	Click it to go to the latest date of camera recording.

## 3 Wizard & Main Interface

### 3.1 Startup Wizard

You can quickly configure the DVR by wizard setup to make the DVR work normally. You must configure the wizard if you start the DVR for the first time (or click “Skip” to cancel the wizard next time). Maybe different versions have different wizard steps. The following wizard steps are for reference only.

- ① Choose the language and locality as needed if it is the first time for you to use the wizard and then read the privacy statement.
- ② **Date and Time Configuration.** The date and time of the system need to be set up if you use the wizard for the first time. Refer to the following figure. Set the time zone, system time, date format and time format. The DST will be enabled by default if the time zone selected includes DST. Click “Next” to continue.

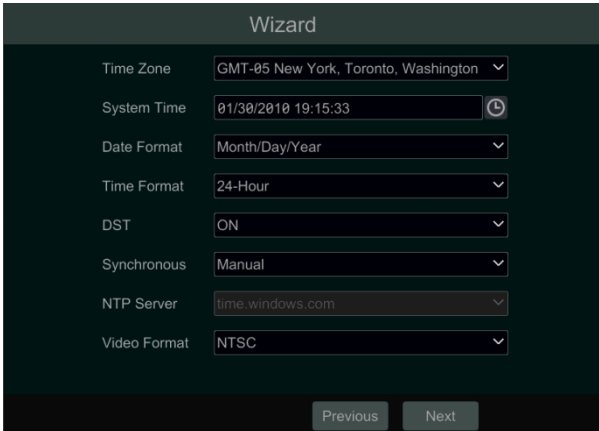

The screenshot shows a 'Wizard' configuration window with the following settings:

Setting	Value
Time Zone	GMT-05 New York, Toronto, Washington
System Time	01/30/2010 19:15:33
Date Format	Month/Day/Year
Time Format	24-Hour
DST	ON
Synchronous	Manual
NTP Server	time.windows.com
Video Format	NTSC

At the bottom of the window, there are two buttons: 'Previous' and 'Next'.

- ③ **System Login.** Set your own password or use the default when you use the wizard for the first time (the default username of the system is *admin* and the default password of admin is *123456*); select the login username and enter the corresponding password next time.

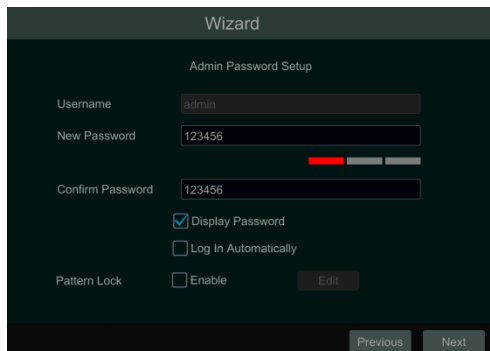

Enable pattern lock and click “Edit” to set the pattern lock.

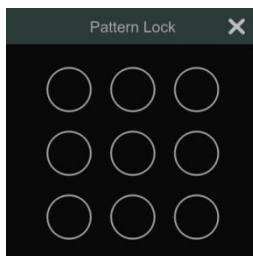

Click “Next” to set questions and answers for password security of admin. If you forget the password, please refer to Q4 in [Appendix A FAQ](#) for details.

Click “Next” to continue.

④ **Disk Settings.** You can view the disk number, disk capacity of the NVR and serial number, R&W status of the disk. Click “Format” to format the disk. Click “Next” to continue. Then click “Wizard Setup”.

⑤ **Network Settings.** Check “Obtain an IP address automatically” and “Obtain DNS automatically” to get the IP address and DNS automatically (the DHCP function of the router in the same LAN should also be enabled), or manually enter them. Enter the HTTP port, RTSP port and Server port (please see [11.1.2 Port Configuration](#) for details). Click “Next” to continue.

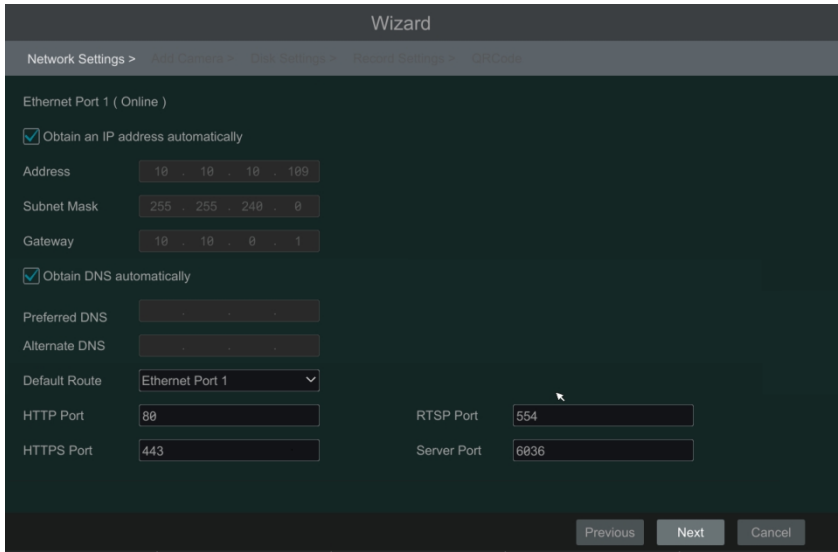

⑥ **Add Camera.** Click “Refresh” to refresh the list of online IP cameras which are in the same local network with DVR and then click to add the searched camera. Click “Add All” to add all the cameras in the list. Click to delete the added camera. Click “Delete All” to delete all the added cameras.



Click to edit the searched IP camera as shown on the below left. Enter the new IP address, subnet mask, gateway and the password of the camera. Click “OK” to save the settings.

Click  to edit the added camera as shown on the above right. Enter the new camera name, IP address, port, username and the password of the camera. You can check “Sync to IPC” to modify the IP address of the IPC via different network segments for being in the same network segment with the DVR. You can click “Test” to test the effectiveness of the input information. Click “OK” to save the settings. You can change the camera name only if it’s an analog camera or the added IPC is online. Click “Next” to continue.

⑦ **Record Settings.** Two record modes are available: auto and manual.

**Auto:** Select one auto mode in the interface as shown below and then click “OK” button to save the settings. See [7.1.1 Mode Configuration](#) for details.

**Manual:** Set the “Sensor Record”, “Motion Record” and “Schedule Record” of each camera. Click “Next” to save the settings. See [7.1.1 Mode Configuration](#) for details.



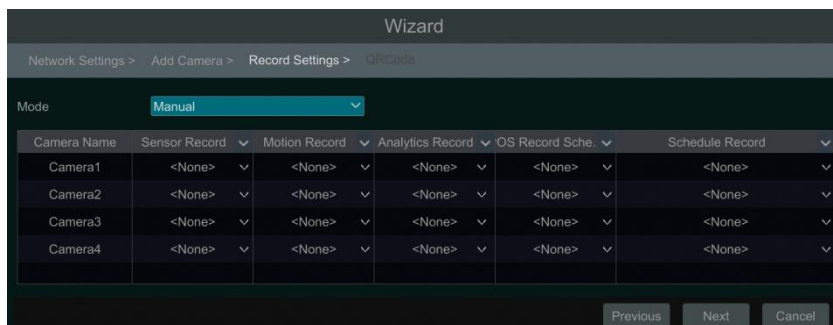

⑧ **QRCode**. Enable the NAT function in the interface or set it in the network configuration after exiting the wizard (please refer to [11.1.7 NAT Configuration](#) for details). You can scan the QRCode through mobile client which is installed in the mobile phone or tablet to log in the mobile client instantly. Please refer to [12.1 Mobile Client Surveillance](#) for details. Click “OK” to save the settings.





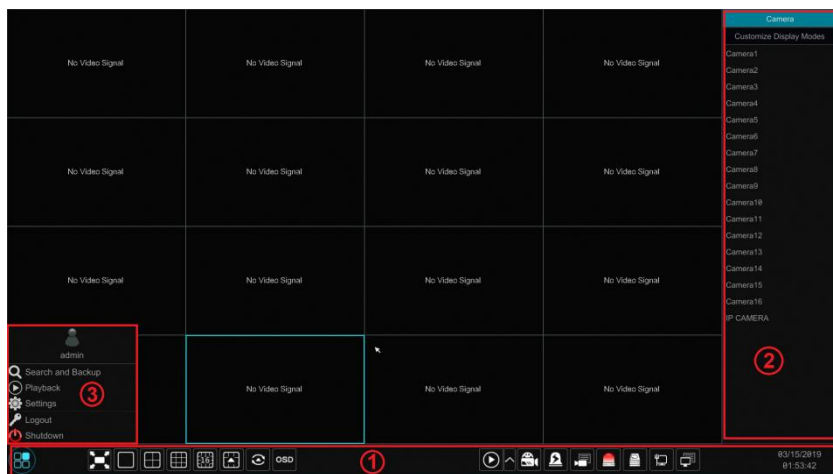







## 3.2 Main Interface

### 3.2.1 Main Interface Introduction



The buttons in area ① are introduced in the table below.

Button	Meaning
	Start button. Click it to pop up area ③.
	Full screen button. Click it to show full screen; click it again to exit the full screen.



Button	Meaning
	Screen mode button.
	Dwell button (see <a href="#">5.2.2 Quick Sequence View</a> and <a href="#">5.2.3 Scheme View In Sequence</a> for details).
	Click it to enable OSD; click again to disable OSD.
	Click  to set the default playback time before starting instant playback ( <a href="#">8.1 Instant Playback</a> ) or going to the playback interface for playback operations ( <a href="#">8.2 Playback Interface Introduction</a> ); click  to go to the playback interface. For instance, if you choose “5 minutes ago” as the default playback time, you can playback the record from the past five minutes.
	Manual record button. Click it to enable/disable record.
	Manual alarm button. Click it to trigger or clear the alarm-out manually in the popup window.
	Record status button. Click it to view the record status.
	Alarm status button. Click it to view the alarm status.
	Disk status button. Click it to view the disk status and RAID status.
	Network status button. Click it to view the network status.
	Information button. Click it to view system information, including basic information, camera status, alarm status, record status, network status, disk information, backup status and user status.

### Introduction of area ②:

Click “Camera” to view all the added cameras in the camera list. Select one camera window on the left side of the interface and then double click one IP camera in the list to preview the camera image in the selected window.

Click “Customize Display Modes” to view all the display modes in the display mode list (refer to [5.2.1 Display Mode](#) for detail configuration of the display mode). Double click one display mode in the list to switch to the display mode for previewing.

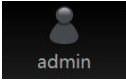
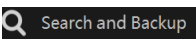
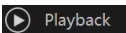
### Introduction of area ③:

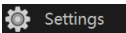
Icon / Button	Meaning
	It shows the current login user.
	Click it to go to record search interface, see <a href="#">8.4 Record Search, Playback &amp; Backup</a> for details.
	Click it to go to playback interface (click  on the tool bar at the bottom of the live view interface to set the default playback time), see <a href="#">8.2 Playback Interface Introduction</a> for details.
	Click it to pop up the setup panel, see <a href="#">3.2.2 Setup Panel</a> for details.

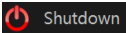
Icon / Button	Meaning
 Logout	Click it to log out the system.
 Shutdown	Click it and then select “Logout”, “Reboot” or “Shutdown” in the popup window.

### 3.2.2 Setup Panel

Click Start→Settings to bring up the setup panel as shown below.

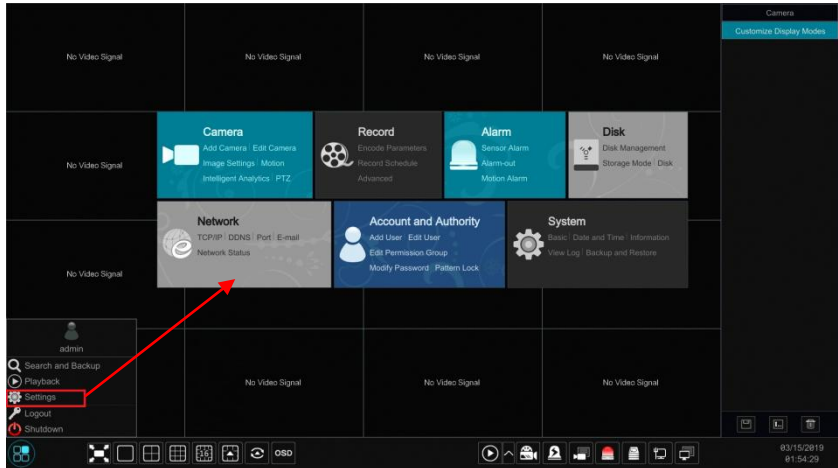

The setup panel includes seven modules. Each module provides some function entries with links for convenient operation.

Here we take **Camera** module as an example. The **Camera** module provides convenient links such as “Add Camera”, “Edit Camera”, “Image Settings”, “Motion”, “Intelligent Detection” and “PTZ”. Click **Camera** to go to the camera management interface as shown below.

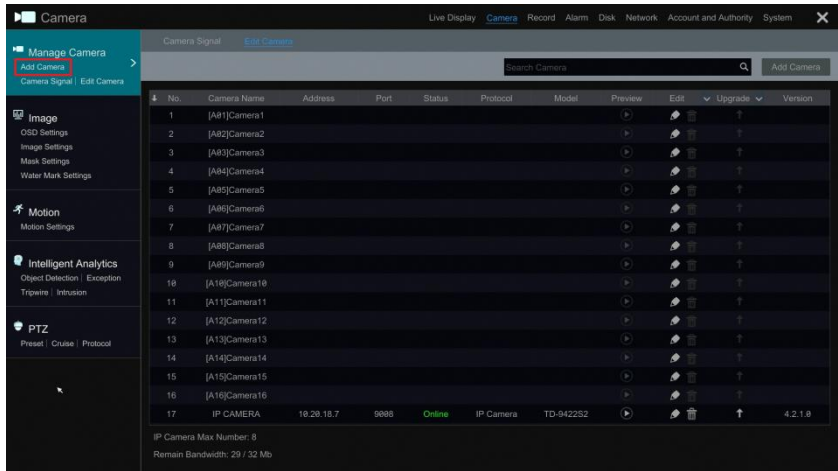

There are some function items on the left side of the camera management interface. Click each item to go to corresponding interface or window. For instance, click “Add Camera” to pop up the window as shown below.

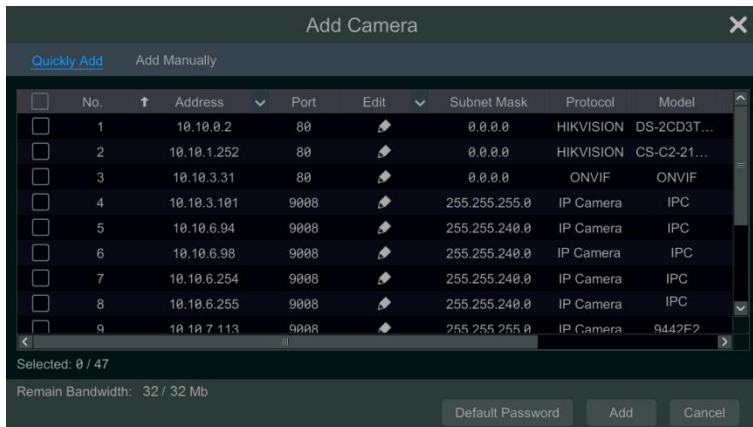

Click the main menus on the top of the camera management interface to go to corresponding interfaces. Refer to the picture below. For instance, you can go to system setup interface by clicking “System” tag.



### 3.2.3 Main Functions

#### ➤ Camera

The module covers the functions such as *Camera Management* (see [Chapter 4 Camera Management](#) for details), *Image Settings* (see [5.4 Image Configuration](#) for details), *Motion* (see [9.2.1 Motion Configuration](#) for details) and *PTZ* (see [Chapter 6 PTZ](#) for details) and so on.

➤ **Record**

The module covers the functions such as *Encode Parameters* and *Record Schedule* and so on. Please see [Chapter 7 Record & Disk Management](#) for details.

➤ **Disk**

The module covers the functions such as *Disk Management*, *Storage Mode* and *Disk Information* and so on. Please see [Chapter 7 Record & Disk Management](#) for details.

➤ **Alarm**

The module covers the functions such as *Sensor and Motion Alarm Handling* and *Alarm Out Settings*. Please see [Chapter 9 Alarm Management](#) for details.

➤ **Network**

The module covers the functions such as *TCP/IP*, *DDNS*, *Port*, *E-mail* and *Network Status* and so on. Please see [11.1 Network Configuration](#) for details.

➤ **Account and Authority**

The module covers the functions such as *Account Management* (see [10.1 Account Management](#) for details) and *Permission Management* (see [10.3 Permission Management](#) for details) and so on.

➤ **System**

The module covers the functions such as *Basic Configuration* (see [11.2 Basic Configuration](#) for details), *Device Information* (see [11.8 View System Information](#) for details), *Log Information* (see [11.7 View Log](#) for details) and *Configuration File Import&Export* (see [11.5 Backup and Restore](#) for details) and so on.

## 4 Camera Management

### 4.1 Camera Signal

Click Start→Settings→Camera→Manage Camera→Camera Signal to go to the interface as shown below.

Some models may support analog signal switching to IP signal, which means decreasing (or increasing) the number of analog channels, accordingly increasing (or decreasing) the number of IP channels with the total channels unchanged.

The DVR device supports hybrid access of TVI, AHD, CVI and CVBS high definition cameras. If the TVI high definition camera is accessed to the DVR, you should select TVI in the following interface to show the camera image normally; if you select AHD, then there will be no image or the image has no color. The default selection of the camera signal is Auto. If you select Auto, the image of the camera will be shown normally regardless of the camera type.

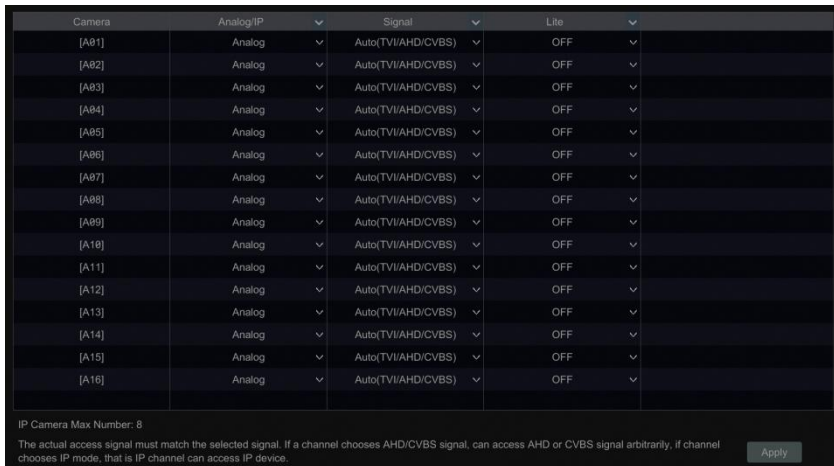

**Note:** You can enable “Lite” in the interface if the DVR supports “Lite” recording. It will lower the recording resolution and increase the recording frame rate. Please enable or disable the Lite as needed.

### 4.2 Add/Edit Camera

#### 4.2.1 Add Camera

The network of the DVR should be set before adding IP camera (see [11.1.1 TCP/IP Configuration](#) for details).

Refer to the pictures below. Click **Add Camera** in the setup panel or  in the top right corner of the preview window to pop up the “Add Camera” window as shown below. You can quickly add or add the IP camera manually.



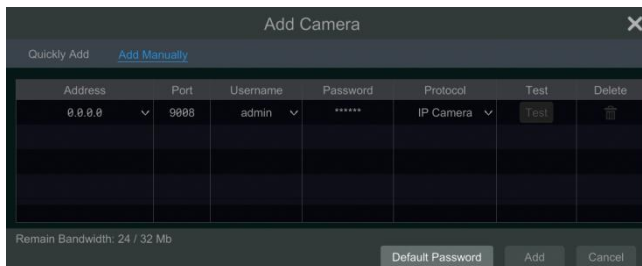

➤ **Quickly Add**

Check the cameras and then click “Add” to add cameras. Click to edit the camera’s IP address, username and password and so on. Click “Default Password” to set the default username and password of each camera.



### ➤ Add Manually

Enter the IP address or domain name (click  in the IP address column to pop up the domain name input window, enter the domain name of the IPC in the window and then click “OK” button), port, username and password of the camera and then select the protocol. Click “Test” to test the effectiveness of the input information and then click “Add” button (you can fill out one camera’s information or above such as IP address, username and password before clicking “Add” button). Click  to delete the camera. Click “Default Password” to set the default username and password of each camera.





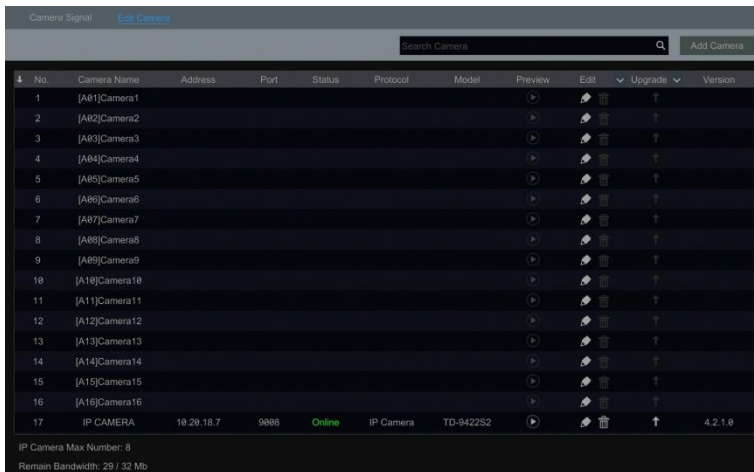

## 4.2.2 Edit Camera

Click “Edit Camera” in the setup panel to go to the interface as shown below.



No.	Camera Name	Address	Port	Status	Protocol	Model	Preview	Edit	Upgrade	Version
1	[A#1]Camera1									↑
2	[A#2]Camera2									↑
3	[A#3]Camera3									↑
4	[A#4]Camera4									↑
5	[A#5]Camera5									↑
6	[A#6]Camera6									↑
7	[A#7]Camera7									↑
8	[A#8]Camera8									↑
9	[A#9]Camera9									↑
10	[A10]Camera10									↑
11	[A11]Camera11									↑
12	[A12]Camera12									↑
13	[A13]Camera13									↑
14	[A14]Camera14									↑
15	[A15]Camera15									↑
16	[A16]Camera16									↑
17	IP CAMERA	19.29.18.7	9888	Online	IP Camera	TD-942252				↑ 4.2.1.0

IP Camera Max Number: 8  
Remain Bandwidth: 29 / 32 Mb

Click  to view the live image of the camera in the popup window. Click  to edit the camera (see [Add camera](#) in [3.1 Startup Wizard](#) for details). Click  to delete the IP camera. Click  in the “Operation” header line and then click “Modify IPC Password” to pop up a window (check the IPCs in the window, set the new password and then click “OK” button; only the online IPCs’ passwords can be modified and a batch of IPCs’ passwords can be modified at the same time). Click  to upgrade an online IPC ( or click  in the “Upgrade” header line and then click “IPC Batch Upgrade” to upgrade a batch of IPCs), select the device which stores the upgrade file in the “Device Name” item of the popup window and the upgrade file in the list (you should select the upgrade IPC model in the window if a batch of IPCs’ passwords need to be modified) and then click “Upgrade” button to start upgrading (the IPC will restart automatically after the upgrade is completed successfully).



## 5 Live View Introduction

### 5.1 Live View Interface Introduction



The connected analog camera will be added automatically in the live view interface for previewing. You should add IP camera manually for previewing (see [4.2.1 Add Camera](#) for details). Refer to the interface as shown below, drag one camera in the preview window to another window for camera window exchanging.

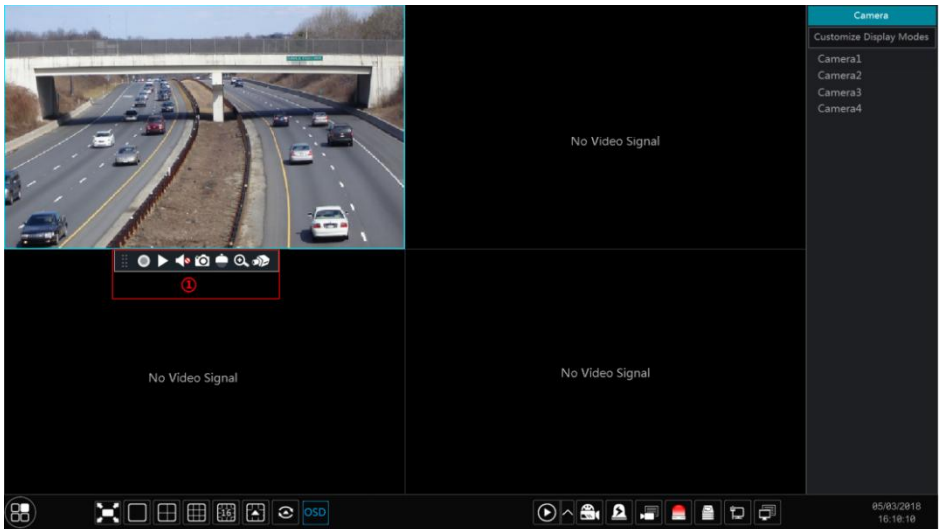

The record symbols with different colors in the live preview window refer to different record types when recording: green stands for manual record, red stands for sensor based record, yellow stands for motion based record, blue stands for schedule record and cyan stands for intelligence record.



Click the preview window to show the tool bar as shown in area ①; right click the preview window to show the menu list. The tool bar and menu list are introduced in the table below.

Button	Menu List	Meaning
	--	Move tool. Click it to move the tool bar anywhere.
	<b>Manually Record On</b>	Click it to start recording.
	<b>Instant Playback</b>	Click  to playback the record; click “Instant Playback” to select or self-define the instant playback time. See <a href="#">8.1 Instant Playback</a> for details.
	<b>Enable Audio</b>	Click it to enable audio. You can listen to the camera audio by enabling audio.
	<b>Snap</b>	Click it to pop up the snap window. Click “Save” in the window to save the image. Click “Export” to export the image.

Button	Menu List	Meaning
	<b>PTZ Control</b>	Click it to go to PTZ control interface. See <a href="#">Chapter 6 PTZ</a> for details.
	<b>Zoom In</b>	Click it to go to single channel amplification interface.
	--	Click it to go to image adjustment interface. Refer to <a href="#">5.4.5 Image Adjustment</a> for details.
--	<b>Camera Info</b>	Click it to view the IP camera information.

The single channel amplification interface is as shown below. Press and drag the blue box to select the zoom in area. Click  /  to zoom the image. Click the camera selection box to select other cameras for amplification. Click “Back” to return to the live view interface.

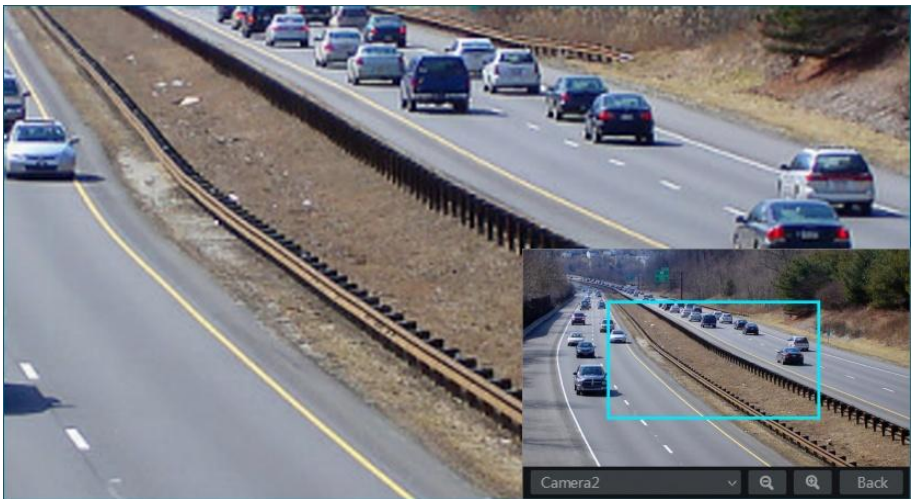

## 5.2 View Mode

### 5.2.1 Display Mode

Set different screen modes and cameras' display sequences as required and then save the display modes classified by surveillance areas, priorities and so on. Refer to the picture below. Double click one display mode in the display mode list to view the live images in this mode.

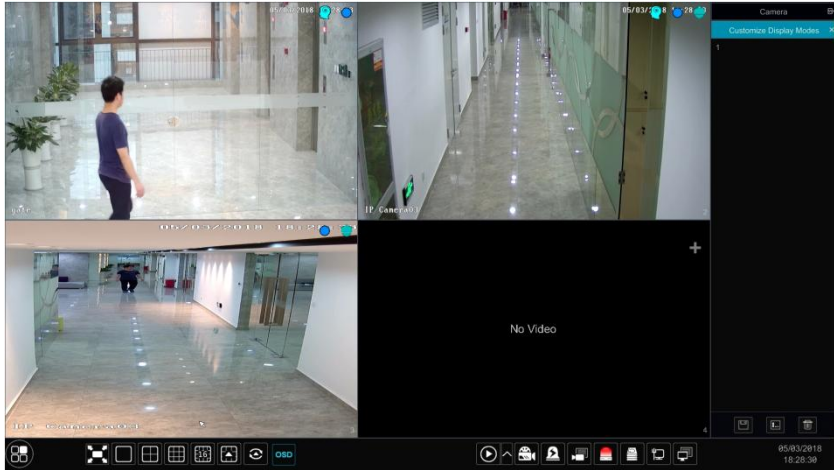

### ➤ Add Display Mode



#### Method One:

- ① Click “Customize Display Modes” in the above interface and then set the screen mode.
- ② Add the cameras and adjust the cameras’ display sequence as needed.
- ③ Click  under the display mode list and then enter the display mode name in the popup window, click the “OK” button to save the current display mode.

#### Method Two:

- ① Click Start→Settings→System→Basic→Output Settings→Main Output to go to the interface and then set the screen mode.
- ② Double click the camera or camera group-in the list to add them to the selected window.
- ③ Click  to save the current display mode (refer to [5.2.3 Scheme View In Sequence](#) for detail configurations). The display mode will be saved and displayed in the display mode list in the live view interface.



### ➤ Edit Display Mode

Click the “Customize Display Modes” tab in the live view interface and then select one display mode in the list. Click  to edit the display mode name; click  to delete the display mode.

## 5.2.2 Quick Sequence View

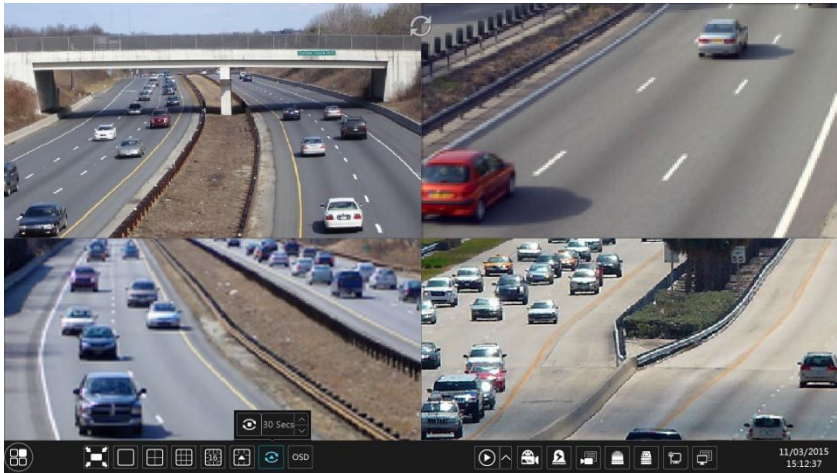

You can start quick sequence view if the scheme has not been created. If the scheme has been created, please refer to [5.2.3 Scheme View in Sequence](#) for details.



Go to the live view interface and then click  to pop up a little window. Set the dwell time in the window and then click  to view the live group by group according to the camera number of the current screen mode. Double click the sequence view interface to pause the view; double click again to restore the view. Click  to stop the view.

### 5.2.3 Scheme View In Sequence

Click Start→Settings→System→Basic→Output Settings→Main Output to go to the interface as shown below.

Area ① displays all the dwell schemes; area ② shows the detailed information of the scheme; area ③ displays all the cameras; area ④ is the tool bar (: clear button; : favorite button, click it to pop up a window, enter the display mode name in the window and then click “OK” to save the current display mode; other buttons are screen mode buttons).

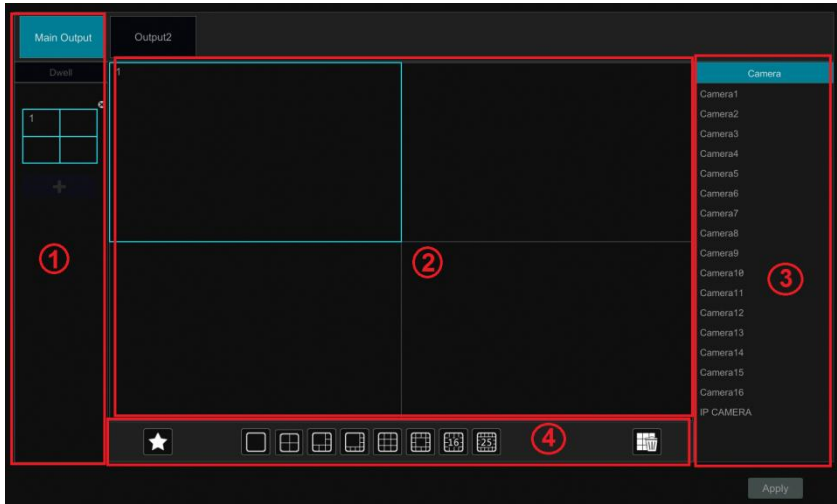

### ➤ Add Scheme

Click **+** in area ① to create a new scheme. Click **✕** on the top right corner of the scheme to delete it.

### ➤ Configure Scheme

- Select a scheme in area ① and then click the screen mode button on the tool bar to set the screen mode of the scheme.
- Select a camera window in area ② and then double click the camera in area ③. The camera will be added into the selected window. One camera in the same scheme cannot repeat. You can click the right-click menu “Clear” in area ② to remove a single camera or click **☒** to remove all the cameras.
- Click “Apply” to save the settings.

### ➤ Start Sequence View

Go to live view interface and then click **👁** to pop up a window. Set the dwell time in the window and then click **👁** to start scheme view in sequence. Double click the sequence view interface to pause the view; double click again to restore the view. Click **👁** to stop the view.

## 5.2.4 Spot View

Click Start→Settings→System→Basic→Output Settings→Output 2 to go to the interface as shown below.

Click **+** on the left to create a new scheme. Each scheme can only add one analog camera. Select a scheme on the left and then double click or drag a camera on the right to the scheme window in the middle of the interface. After finishing the settings of all the schemes, select the dwell time and click “Apply” to start playing the schemes in sequence in output 2.

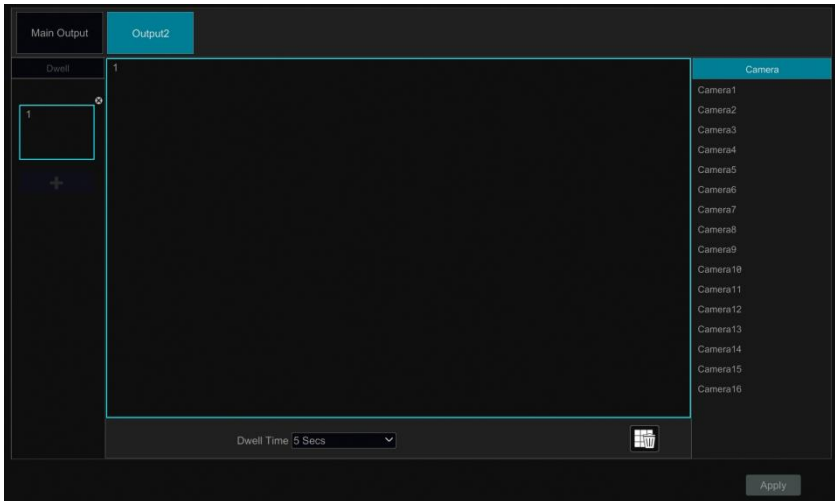

### 5.3 POS Settings

Some models may not support this function.

- ① Click Start→Settings→Basic→POS Settings to go to the interface.
- ② Enable POS and click configure under “Connection Settings” to go to the following interface.
- ③ Enter the IP address of the POS you want to add.
- ④ Check “Filter destination”, “Filter POS port” and “Filter destination Port” (If you do not check them, please skip this step) and Enter the destination IP, POS port and destination port you want to filter.

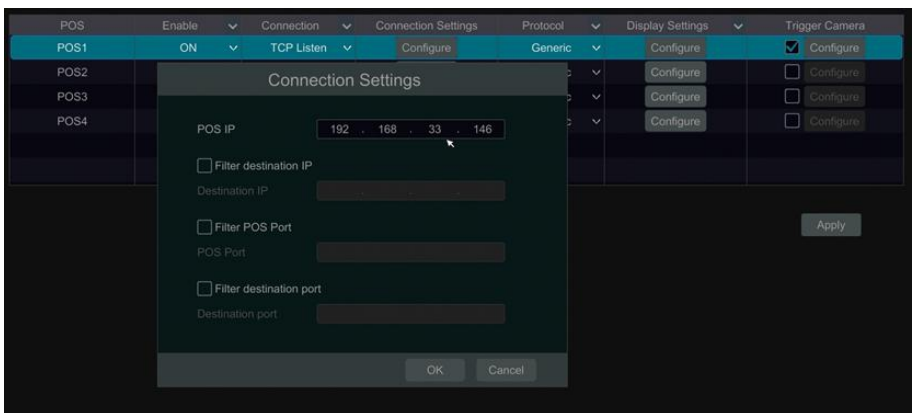

- ⑤ Click “Display Position” under “Display Settings” to set the position of the POS information (Use the default settings of the general settings).

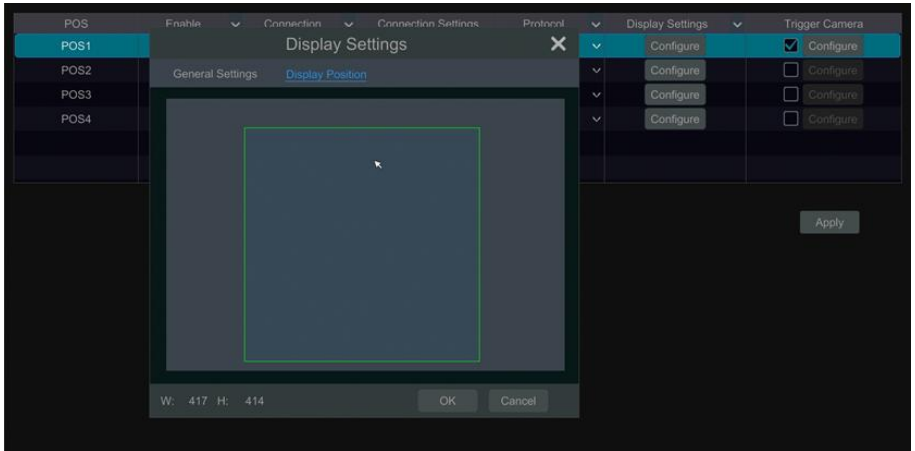

⑥ Check “Trigger Camera” and click configure under it to bind POS to the camera. One POS can be bound to multiple channels, but one channel can only be bound to one POS.

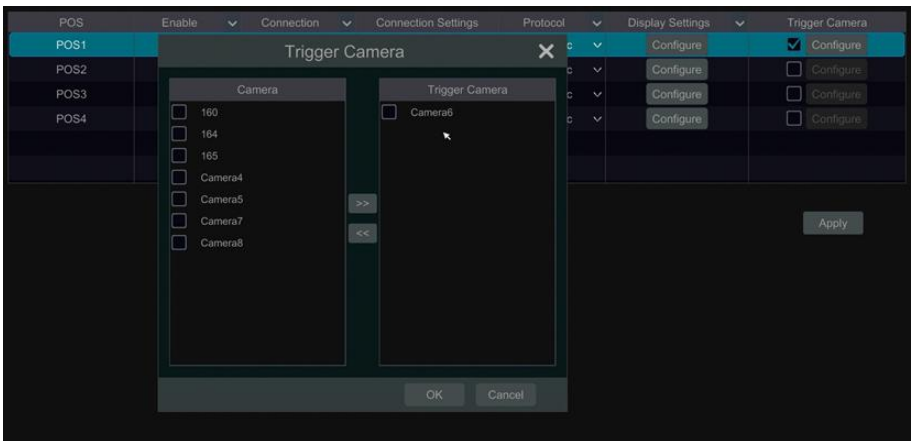

⑦ Click “Apply” to save the settings and then the trade information will be displayed on the preview image in real-time.  
One POS is bound to one camera:

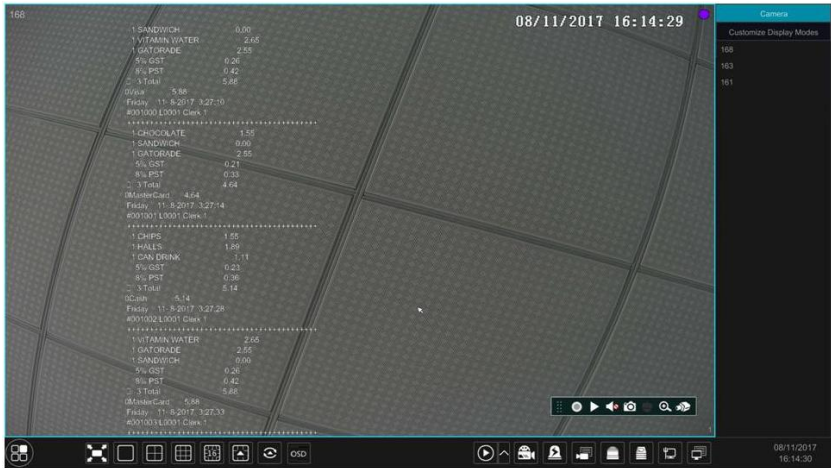

One POS is bound to multiple cameras:

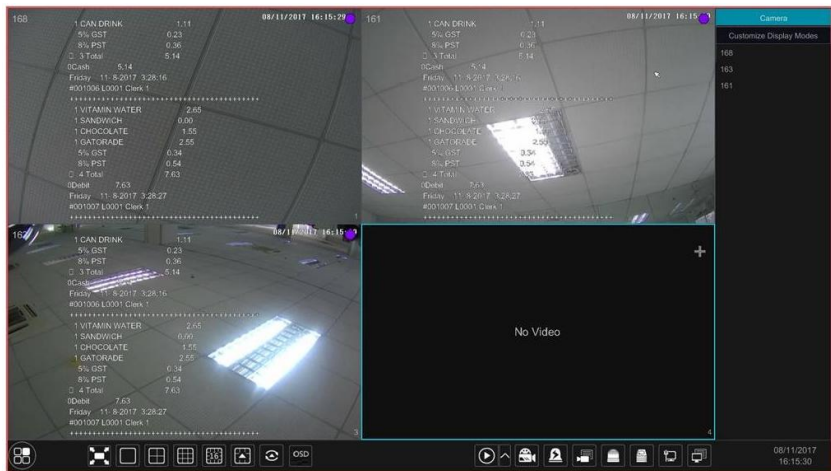

## 5.4 Image Configuration

### 5.4.1 OSD Settings

Click Start→Settings→Camera→Image→OSD Settings to go to the interface as shown below. Select the camera, enter the camera name (or double click the camera name in the camera list to change the camera name), enable or disable the name and time OSDs (if enabled, drag the red name and time OSDs directly in the image view area to change the OSDs’ display position) and select the date, time format and color. Click “Apply” to save the settings.



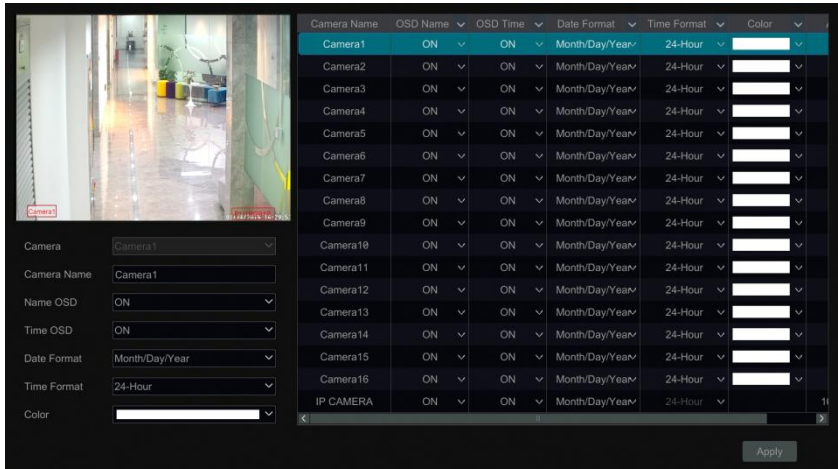

### 5.4.2 Image Settings

Click Start→Settings→Camera→Image→Image Settings to go to the following interface. Select the camera and then set the brightness, contrast, saturation and hue of the camera. Click “Advanced” button or  in the camera list on the right side of the interface to pop up “Image Adjust” interface and then set the relevant setting items. Please refer to [5.4.5 Image Adjustment](#) for detailed introductions of these items.

You can click “Default” button to restore the image settings to the default factory settings.

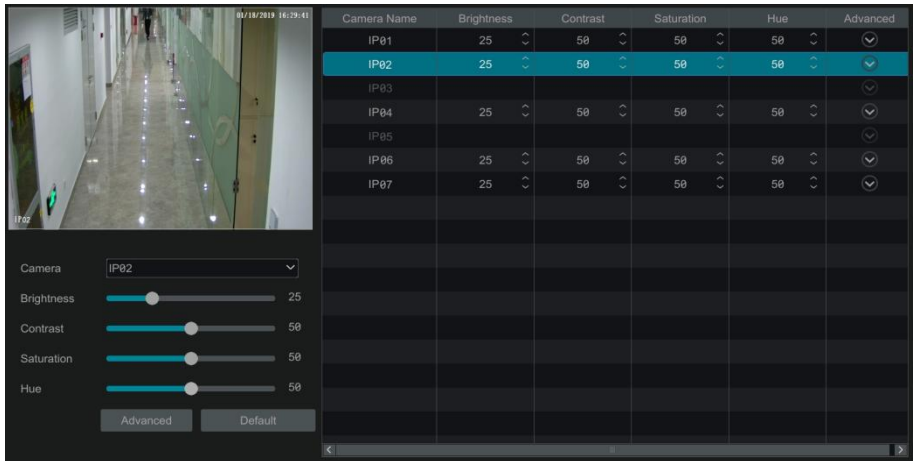

### 5.4.3 Mask Settings

Some areas of the image can be masked for privacy. Up to four mask areas can be set for each camera. Click Start→Settings→Camera→Image→Mask Settings to go to the interface as shown below. Select the camera and enable the mask. Click “Draw” button and then drag the

mouse on the image area to set the mask area; click “Delete” button to delete the mask areas; click “Apply” to save the settings.

Camera Name	Mask	Color
Camera1	ON	Black
Camera2	OFF	Black
Camera3	OFF	Black
Camera4	OFF	Black

Apply

### 5.4.4 Water Mark Settings

Click Start→Settings→Camera→Image→Water Mark Settings to go to the interface as shown below. Select the camera and enable water mark and then enter the water mark information. Click “Apply” to save the settings.

Camera Name	Water Mark	Information
Camera1	ON	XXXXX
Camera2	OFF	
Camera3	OFF	
Camera4	OFF	

Apply

## 5.4.5 Image Adjustment

Go to live view interface and then click  button on the tool bar under the camera window to go to the image adjustment interface.

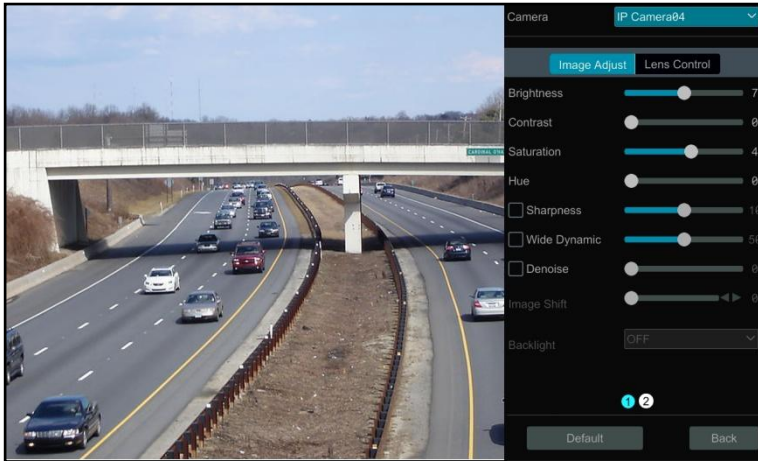

### ➤ Image Adjustment



Select the camera and then click “Image Adjustment” to go to image adjustment tab. Refer to the above picture. Drag the slider to set the camera’s brightness, contrast, saturation and hue value. Check sharpen, wide dynamic and denoise and then drag the slider to set the value. Click “Default” button to set these parameters to default values.

The introductions of these parameters are as follows:

Parameter	Meaning
Brightness	It is the brightness level of the camera’s image.
Contrast	It is the color difference between the brightest and darkest parts.
Saturation	It is the degree of color purity. The color is purer, the image is brighter.
Hue	It refers to the total color degree of the image.
Sharpen	It refers to the resolution level of the image plane and the sharpness level of the image edge.
Wide Dynamic	The wide dynamic range (WDR) function helps the camera provide clear images even under back light circumstances. When there are both very bright and very dark areas simultaneously in the field of view, WDR balances the brightness level of the whole image and provide clear images with details.
BLC	HLC: lowers the brightness of the entire image by suppressing the brightness of the image’s bright area and reducing the size of the halo area. BLC: If enabled, the auto exposure will activate according to the scene so that the object of the image in the darkest area will be seen clearly.
Denoise	Decrease the noise and make the image more thorough. Increasing the value will make the noise reduction effect better but it will reduce the image resolution.







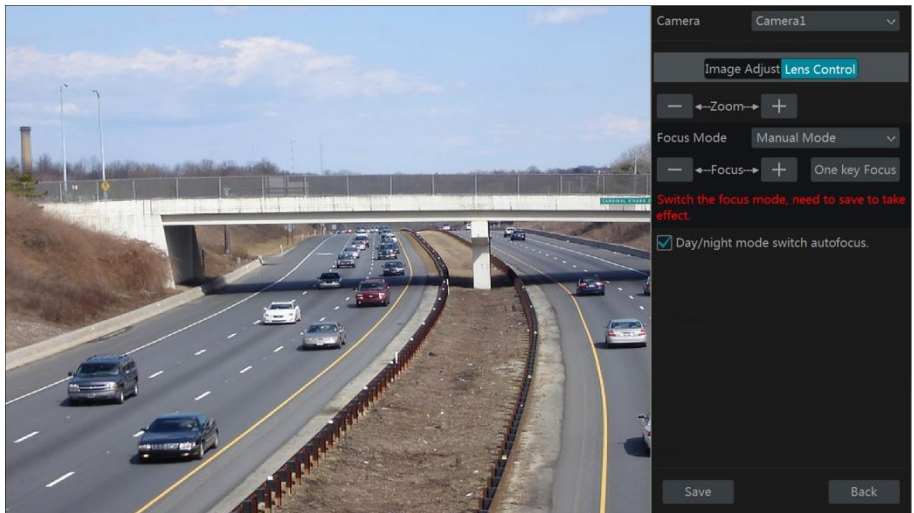

Parameter	Meaning
White Balance	Adjust the color temperature according to the environment automatically.
Image Mirror	Turn the current video image horizontally.
Image Flip	Turn the current video image vertically.

➤ **Lens Control**

Select the camera and then click “Lens Control” to go to lens control tab. Click  or  to adjust the zoom and focus parameters of the camera’s lens. Click “Save” to save the settings.

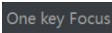

The introductions of these parameters and buttons are as follows:

Button/Parameter	Meaning
 	Click  /  to zoom in/out the image.
Focus Mode	If manual mode is selected, focus button & “One Key Focus” & “Day/night mode switch autofocus” will be available; if auto mode is selected, the time interval setup will be available.
 	Click  /  to increase/decrease the focal length.
	Click it to focus instantly.
Day/night mode switch autofocus	If checked, the lens will focus automatically when the camera is switching day/night mode.
Time Interval	It is the time interval when camera lens is auto-focusing. The interval can be set in the drop-down list.

*Note: This function is only available for the models with auto varifocal lens, or the settings here are ineffective.*

## 6 PTZ







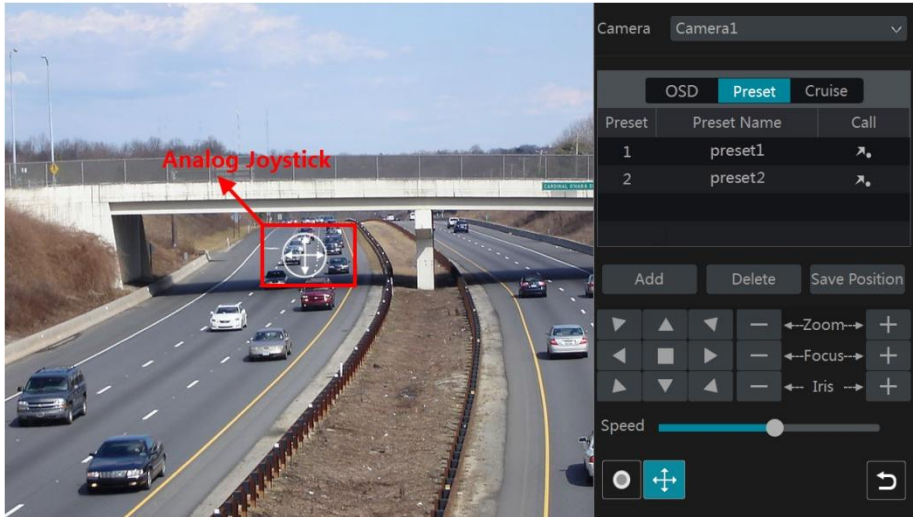













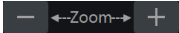

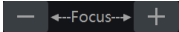

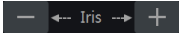
### 6.1 PTZ Control Interface Introduction

You can control the dome or PTZ which connects to the camera for PTZ control.

Click  on the tool bar at the bottom of the live preview window to go to the PTZ control interface as shown below. You can select another dome or PTZ which connects to the camera on the top right of the interface for PTZ control.



Introductions of the buttons on the bottom right of the interface:

Button	Meaning
	Click  /  /  /  /  /  /  /  /  to rotate the dome. Click  to stop rotating the dome.
	Click  /  to zoom in / out the camera image.
	Click  /  to increase / decrease the focal length.
	Click  /  to increase / decrease the iris of the dome.
	Drag the slider to adjust the rotating speed of the dome.
	Click  /  to start / stop recording.
	Click  /  to hide / show the analog joystick.

Button	Meaning
	Click it to return to the live view interface.

### ➤ Analog Joystick Control

The analog joystick on the left side of the interface provides quick PTZ control. The dome or PTZ will rotate when you drag the analog joystick. The farther you drag the analog joystick from the middle of the image, the faster the dome or PTZ rotates. The dome or PTZ will stop rotating when you stop dragging the analog joystick.

### ➤ 3D Control

Click the camera image on any area and then the image will be centered on the clicked point. Refer to the picture as shown below. Drag the mouse from A to B to get a green rectangle and the rectangle area will be zoomed in.



Refer to the picture as shown below. Drag the mouse from C to D to get a green rectangle and the rectangle area will be zoomed out.



### ➤ Advanced 3D Control

Double click the left button of the mouse on any area of the camera image and then the image size will be doubled and centered on the clicked point.



Press and hold the left button of the mouse on any area of the camera image to zoom in the image; press and hold the right button to zoom out the image.





Move the cursor of the mouse to the camera image and then slide the scroll wheel of the mouse forward to zoom in the image, slide the scroll wheel of the mouse backward to zoom out the image.

### ➤ OSD Setting

Go to PTZ protocol setting interface and then set the protocol to COC before you bring up the OSD. Click “OSD Menu” to go to camera OSD setting interface. Click  to start OSD setting. The meanings of the buttons are shown in the table below.





Button	Meaning
	Click it to call main menu or enter the sub menu or confirm the settings.
	Click it to call main menu or enter the sub menu or confirm the settings.

Button	Meaning
	Click it to change the menu mode or decrease the menu value.
	Click it to change the menu mode or increase the menu value.
	Click it to go to the previous menu.
	Click it to go to the next menu.

### ➤ Preset Setting

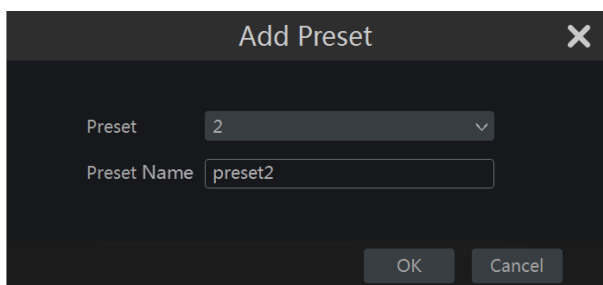
Click “Preset” to go to preset operation tab and then click “Add” button to pop up a window as shown below. Select the preset and then enter the preset name in the window; finally click “OK” button to save the settings. You can add 255 presets for each dome at most.



Adjust the dome’s direction and then click “Save Position” to save the current preset position (you can also click another preset in the preset list and then save the preset position after adjusting the dome’s direction); click  in the preset list to call the preset; click “Delete” button to delete the selected preset.

You can also go to preset setting interface for preset setting, see [6.2 Preset Setting](#) for details.



### ➤ Cruise Setting

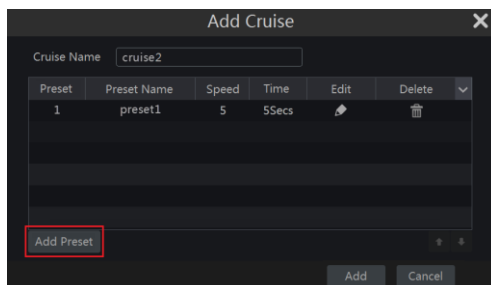

Click “Cruise” to go to cruise operation tab and then click “Add” button to pop up a window as shown below left. You can add 8 cruises for each dome at most.

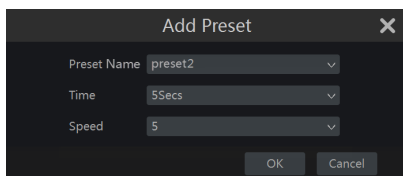





- ① Enter the cruise name in the “Add Cruise” window and then click “Add preset” to pop up the “Add Preset” window (Before adding preset to the cruise, please add preset of the dome first).
- ② In the “Add Preset” window, select the preset name, preset time and preset speed and then click “OK” button.
- ③ In the “Add Cruise” window, you can click  to reselect the preset, then change the preset time and speed. Click  to delete the preset. Click “Add” button to save the cruise.

Click  to start the cruise and click  to stop the cruise in the cruise list of the cruise operation tab; click “Delete” button to delete the selected cruise.



You can also go to cruise setting interface for cruise setting, see [6.3 Cruise Setting](#) for details.

## 6.2 Preset Setting

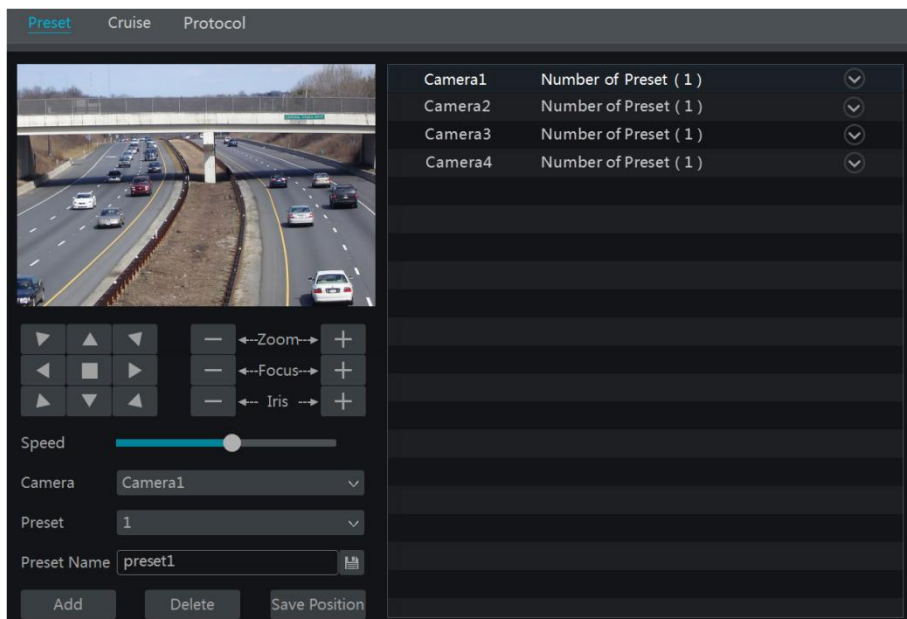
Click Start→Settings→Camera→PTZ→Preset to go to the interface as shown below.



### ➤ Add preset

Select camera and then click “Add” button to add preset; or click  in the camera list on the right side of the interface to display the preset information of the dome and then click  to add preset. The operations of the “Add Preset” window are similar to that of the PTZ control interface; please see [6.1 PTZ Control Interface Introduction](#) for details.

#### ➤ Edit preset

Select camera and preset. You can enter the new name of the preset and then click  to save the new preset name. Adjust the rotating speed, position, zoom, focus and iris of the preset and then click “Save Position” to save the preset.

#### ➤ Delete Preset



Select camera and preset and then click “Delete” to delete the preset.

## 6.3 Cruise Setting

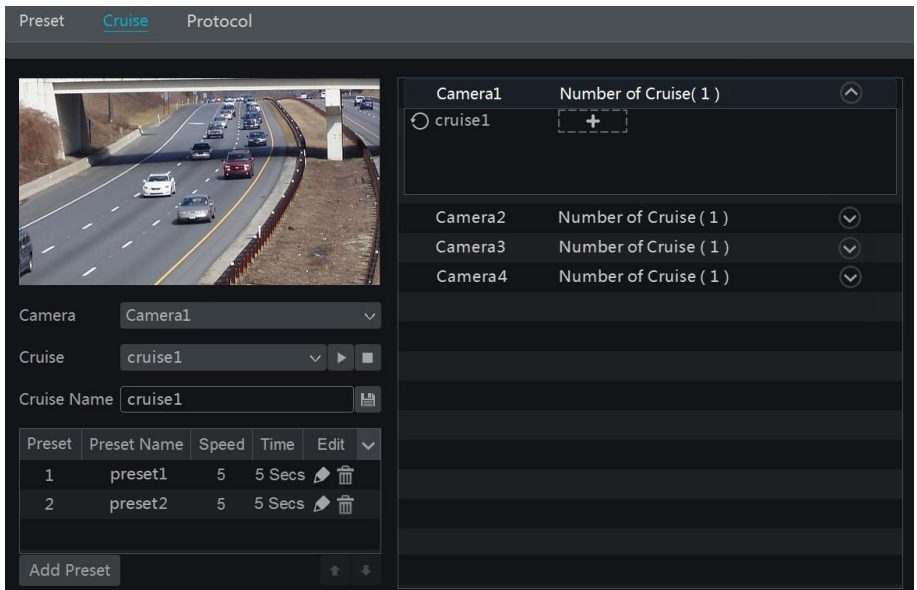





Click Start→Settings→Camera→PTZ→Cruise to go to the interface as shown below.





#### ➤ Add Cruise

Click  in the camera list on the right side of the interface to display the cruise information of the dome and then click  to add cruise. The operations of the “Add Cruise” window are similar to that of the PTZ control interface; please see [6.1 PTZ Control Interface Introduction](#) for details.

#### ➤ Edit Cruise

Select the camera and cruise in the “Cruise” interface. Enter the new cruise name and then click  to save the cruise name. Click “Add Preset” to add preset to the cruise. Click  to edit the preset. Click  to delete the preset from the cruise. Click one preset in the preset list and then click  to move down the preset and click  to move up the preset. Click  to start the cruise and click  to stop it.

### ➤ Delete Cruise

Click  in the camera list on the right side of the interface to display the cruise information of the dome and then click  on the top right corner of the cruise to delete the cruise.

## 6.4 PTZ Protocol Setting

Click Start→Settings→Camera→PTZ→Protocol to go to the interface as shown below. You can enable or disable the PTZ and set the protocol, baud rate and address of the analog dome in the interface. Please make sure the analog speed dome camera is well connected to the DVR before you control it.

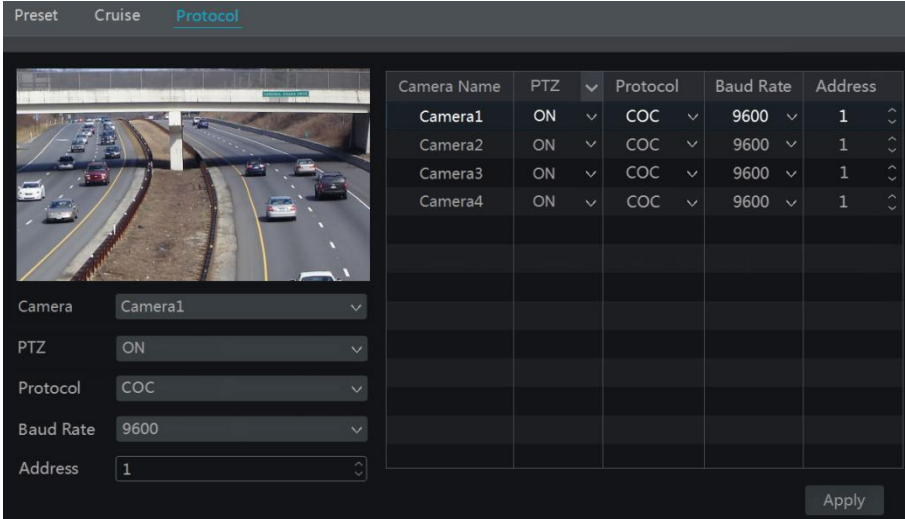

Camera Name	PTZ	Protocol	Baud Rate	Address
Camera1	ON	COC	9600	1
Camera2	ON	COC	9600	1
Camera3	ON	COC	9600	1
Camera4	ON	COC	9600	1

Camera: Camera1  
 PTZ: ON  
 Protocol: COC  
 Baud Rate: 9600  
 Address: 1

Apply

Select the camera and enable PTZ and then set the protocol, baud rate and address of the dome according to the settings of the dome.

**Protocol:** The default communication protocol of the DVR is COC. Range from: PELCOP, PELCOD, LILIN, MINKING, NEON, STAR, VIDO, DSCP, VISCA, COC, etc.

**Address:** The address of the PTZ device.

**Baud Rate:** Baud rate of the PTZ device. Range from: 110, 300, 600, 1200, 2400, 4800, 9600, 19200, 34800, 57600, 115200, 230400, 460800, 921600.

# 7 Record & Disk Management

## 7.1 Record Configuration

### 7.1.1 Mode Configuration

Please format the HDDs before recording (refer to [7.5 Disk Management](#) for details). Click Start→Settings→Record→Mode Settings to go to the mode settings interface. You can set the record time under the “Manual Record Settings” and then click “Apply” button to save the settings. There are two record modes: auto mode and manual mode.

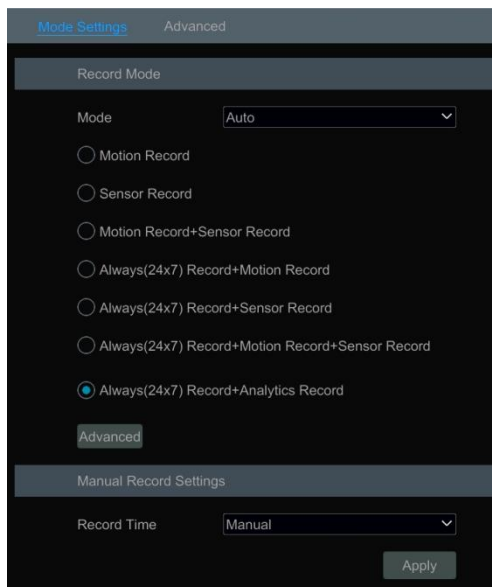

#### ➤ Auto Mode

**Motion Record:** Motion alarm record will be enabled when motion alarm happens.

**Sensor Record:** Sensor alarm record will be enabled when sensor alarm happens.

**Motion Record+Sensor Record:** Motion/sensor alarm record will be enabled when motion/sensor alarm happens.

**Always(24 x7) Record+Motion Record:** Normal record is enabled all the time; motion alarm record will be started when motion alarm happens.

**Always(24 x7) Record+Sensor Record:** Normal record is enabled all the time; sensor alarm record will be started when sensor alarm happens.

**Always(24 x7) Record+Motion Record+Sensor Record:** Normal record is enabled all the time; motion/sensor alarm record will be enabled when motion/sensor alarm happens.

**Always(24 x7) Record+Motion Record+Sensor Record+Analytics Record:** Normal record is enabled all the time; motion/sensor/intelligence alarm record will be enabled when

motion/sensor/intelligence alarm happens.

**Always(24 x 7) Record+Motion Record+Sensor Record+Analytics Record+POS Record:**

Normal record is enabled all the time; motion/sensor/Analytics/POS alarm record will be enabled when motion/sensor/ Analytics /POS alarm happens.

Some models may not support POS recording.

You can add more auto modes on intelligence record. Click “Advanced” button to pop up a window as shown below. Check the modes in the window and then click “Add” button to show the modes in the record mode list (in the window, the checked modes can be shown in the record mode list while the unchecked modes cannot; you cannot only check “**Always(24 x 7) Record**”).

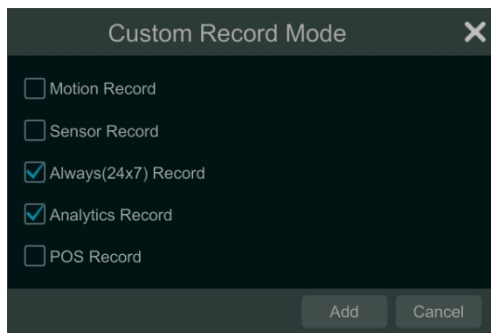

Select one auto mode to pop up the corresponding window. Set the encode, GOP, resolution, FPS, bitrate type, quality, max bitrate and audio of each camera and then click “OK” to save the settings. Please adjust the parameters according to the actual condition.

Camera Name	Stream Type	Encode	Resolution	FPS	Bitrate Type	Quality	Max Bitrate	Bitrate Limit Recommended Range	Audio	GOP
Camera1	Main Stream	H.265	1920x1080	30	VBR	Higher	2048Kbps	5145-8579Kbps	ON	60
Camera2	Main Stream	H.265	784x480	7	VBR	Higher	512Kbps	266-444Kbps	ON	14
Camera3	Main Stream	H.265	784x480	7	VBR	Higher	512Kbps	266-444Kbps	ON	14
Camera4	Main Stream	H.265	784x480	7	VBR	Higher	512Kbps	266-444Kbps	ON	14
Camera5	Main Stream	H.265	784x480	7	VBR	Higher	512Kbps	266-444Kbps	ON	14
Camera6	Main Stream	H.265	784x480	7	VBR	Higher	512Kbps	266-444Kbps	ON	14
Camera7	Main Stream	H.265	784x480	7	VBR	Higher	512Kbps	266-444Kbps	ON	14
Camera8	Main Stream	H.265	784x480	7	VBR	Higher	512Kbps	266-444Kbps	ON	14
Camera9	Main Stream	H.265	784x480	7	VBR	Higher	512Kbps	266-444Kbps	ON	14
Camera10	Main Stream	H.265	784x480	7	VBR	Higher	512Kbps	266-444Kbps	ON	14
Camera11	Main Stream	H.265	784x480	7	VBR	Higher	512Kbps	266-444Kbps	ON	14
Camera12	Main Stream	H.265	784x480	7	VBR	Higher	512Kbps	266-444Kbps	ON	14
Camera13	Main Stream	H.265	784x480	7	VBR	Higher	512Kbps	266-444Kbps	ON	14

Remain Bandwidth: 29 / 32 Mb    Predict Record Time 8 Day    OK    Cancel

**Video Encode:** the video encode format of the camera.

**GOP:** group of pictures.

**Resolution:** the higher the resolution is, the clearer the image is.

**FPS:** the higher the frame rate is, the more fluency the video is. However, more storage room

will be taken up.

**Bitrate Type:** CBR and VBR are optional. CBR means that no matter how much change is seen in the video scene, the compression bitrate will be kept constant. VBR means that the compression bitrate will be adjusted according scene changes. For example, for scenes that do not have much movement, the bitrate will be kept at a lower value. This will help to optimize the network bandwidth.

**Quality:** When VBR is selected, you need to choose image quality. The higher the image quality you choose, the more bitrate will be required.

**Max Bitrate:** 32Kbps ~10240Kbps are optional.

### ➤ Manual Mode

If the manual mode is selected, you need to set the encode parameters and record schedules of each camera. See [7.2 Encode Parameters Setting](#) and [7.3 Schedule Setting](#) for details.

## 7.1.2 Advanced Configuration

Click Start→Settings→Record→Advanced to go to the following interface. Enable or disable cycle record (cycle record: the earliest record data will be replaced by the latest when the disks are full). Set the stream, pre-alarm record time, post-alarm record time and expiration time of each camera and then click “Apply” to save the settings.

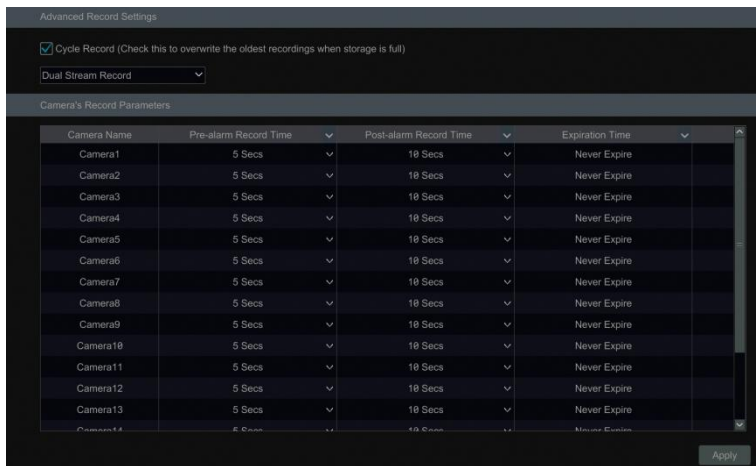

**Pre-alarm Record Time:** set the time to record before the actual recording begins.

**Post-alarm Record Time:** set the time to record after the actual recording is finished.

**Expiration Time:** set the expiration time for recorded video. If the set date is overdue, the recorded data will be deleted automatically.

## 7.2 Encode Parameters Setting

Click Start→Settings→Record→Encode Parameters to go to the interface as shown below. Set the encode, resolution, FPS, bitrate type, quality, max bitrate and audio of main stream for each

camera in “Event Recording Settings” and “Schedule Recording Settings” interfaces. Click “Apply” to save the settings. You can set the record stream of each camera one by one or set them in bulk for all cameras.

Camera Name	Stream Type	Encode	Resolution	FPS	Bitrate Type	Quality	Max Bitrate	Bitrate Limit	Recommended Range	Audio
Camera1	Main Stream	H.265	1920x1080	30	VBR	Higher	2848Kbps	5145	8576Kbps	ON
Camera2	Main Stream	H.265	784x480	7	VBR	Higher	512Kbps	266	444Kbps	ON
Camera3	Main Stream	H.265	784x480	7	VBR	Higher	512Kbps	266	444Kbps	ON
Camera4	Main Stream	H.265	784x480	7	VBR	Higher	512Kbps	266	444Kbps	ON
Camera5	Main Stream	H.265	784x480	7	VBR	Higher	512Kbps	266	444Kbps	ON
Camera6	Main Stream	H.265	784x480	7	VBR	Higher	512Kbps	266	444Kbps	ON
Camera7	Main Stream	H.265	784x480	7	VBR	Higher	512Kbps	266	444Kbps	ON
Camera8	Main Stream	H.265	784x480	7	VBR	Higher	512Kbps	266	444Kbps	ON
Camera9	Main Stream	H.265	784x480	7	VBR	Higher	512Kbps	266	444Kbps	ON
Camera10	Main Stream	H.265	784x480	7	VBR	Higher	512Kbps	266	444Kbps	ON
Camera11	Main Stream	H.265	784x480	7	VBR	Higher	512Kbps	266	444Kbps	ON
Camera12	Main Stream	H.265	784x480	7	VBR	Higher	512Kbps	266	444Kbps	ON
Camera13	Main Stream	H.265	784x480	7	VBR	Higher	512Kbps	266	444Kbps	ON
Camera14	Main Stream	H.265	784x480	7	VBR	Higher	512Kbps	266	444Kbps	ON
Camera15	Main Stream	H.265	1920x1080	30	VBR	Higher	2848Kbps	5145	8576Kbps	ON
Camera16	Main Stream	H.265	784x480	7	VBR	Higher	512Kbps	266	444Kbps	ON
IP CAMERA	Main Stream	H.265	1920x1080	30	VBR	Higher	2848Kbps	5145	8576Kbps	ON

Remain Bandwidth: 29 / 32 Mb    Predict Record Time: 8 Day   

Click Start→Settings→Record→Stream Settings to go to “Sub Stream” interface. Set the encode, resolution, FPS, bitrate type, quality and max bitrate of sub-stream for each camera in the interface and then click “Apply” to save the settings.

Camera Name	Stream Type	Encode	Resolution	FPS	Bitrate Type	Quality	Max Bitrate	Bitrate Limit	Recommended Range	GOP
Camera1	Sub Stream	H.265	1920x1080	30	VBR	Higher	1824Kbps	1824	8576Kbps	66
Camera2	Sub Stream	H.265	784x480	7	VBR	Higher	512Kbps	266	444Kbps	14
Camera3	Sub Stream	H.265	784x480	7	VBR	Higher	512Kbps	266	444Kbps	14
Camera4	Sub Stream	H.265	784x480	7	VBR	Higher	512Kbps	266	444Kbps	14
Camera5	Sub Stream	H.265	784x480	7	VBR	Higher	512Kbps	266	444Kbps	14
Camera6	Sub Stream	H.265	784x480	7	VBR	Higher	512Kbps	266	444Kbps	14
Camera7	Sub Stream	H.265	784x480	7	VBR	Higher	512Kbps	266	444Kbps	14
Camera8	Sub Stream	H.265	784x480	7	VBR	Higher	512Kbps	266	444Kbps	14
Camera9	Sub Stream	H.265	784x480	7	VBR	Higher	512Kbps	266	444Kbps	14
Camera10	Sub Stream	H.265	784x480	7	VBR	Higher	512Kbps	266	444Kbps	14
Camera11	Sub Stream	H.265	784x480	7	VBR	Higher	512Kbps	266	444Kbps	14
Camera12	Sub Stream	H.265	784x480	7	VBR	Higher	512Kbps	266	444Kbps	14
Camera13	Sub Stream	H.265	784x480	7	VBR	Higher	512Kbps	266	444Kbps	14
Camera14	Sub Stream	H.265	784x480	7	VBR	Higher	512Kbps	266	444Kbps	14
Camera15	Sub Stream	H.265	1920x1080	30	VBR	Higher	1824Kbps	1824	8576Kbps	66
Camera16	Sub Stream	H.265	784x480	7	VBR	Higher	512Kbps	266	444Kbps	14
IP CAMERA	Sub Stream	H.265	784x480	30	VBR	Higher	512Kbps	1824	1715Kbps	66

Predict Record Time: 9 Day   

## 7.3 Schedule Setting

### 7.3.1 Add Schedule

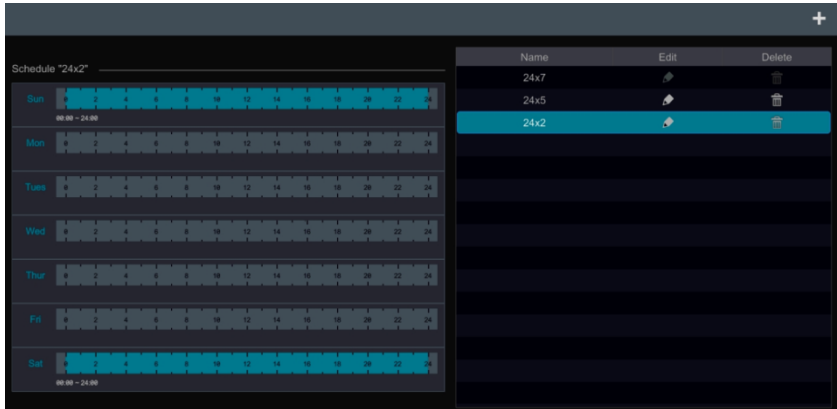

Click Start→Settings→Record→Record Schedule→Edit Schedules to go to the interface as

shown below. “24 x 7”, “24 x 5” and “24 x 2” are the default schedules; you cannot edit or delete “24 x 7” while “24 x 5” and “24 x 2” can be edited and deleted. Click the schedule name to display the detailed schedule information on the left side of the interface. The seven rows stand for the seven days in a week and each row stands for 24 hours in a day. Blue stands for the selected time and gray stands for unselected time.



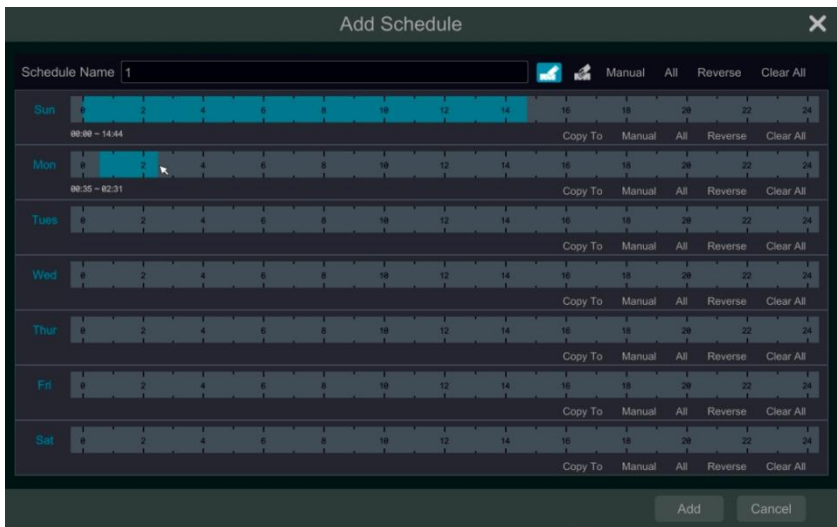

Click  to add a new schedule. Refer to the picture below.





Set the schedule name and schedule time and then click “Add” to save the schedule. You can set day schedule or week schedule. : add button; : delete button.

### ➤ Set Day Schedule



Click  and then drag the cursor on the time scale to set record time; click  and then drag the cursor on the time scale to delete the selected area.

You can manually set the record start time and end time. Click  or  and then click “Manual” on each day to pop up a window as shown below. Set the start and end time in the window and then click “OK” to save the settings.

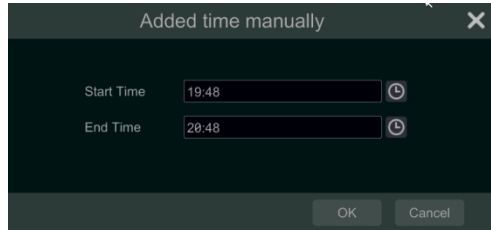

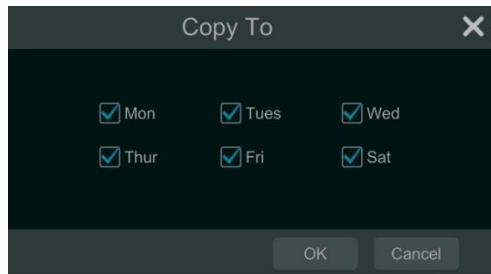

Click “All” to set all day recording; click “Reverse” to swap the selected and unselected time in a day; click “Clear All” to clear all the selected area in a day.

Click “Copy To” to copy the schedule of the day to other days. Refer to the picture below. Check the days in the window and then click “OK” to save the settings.



### ➤ Set Week Schedule

Click  or  and then click “Manual” beside  to set the week schedule. Refer to the picture below. Set the start and end time, check the days in the window and then click “OK” to save the settings.

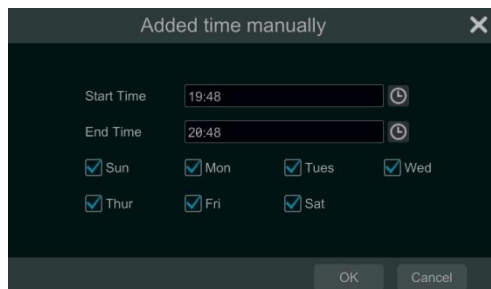



Click “All” to set all week recording; click “Reverse” to swap the selected and unselected time in a week; click “Clear All” to clear all the selected area in a week.

### 7.3.2 Record Schedule Configuration

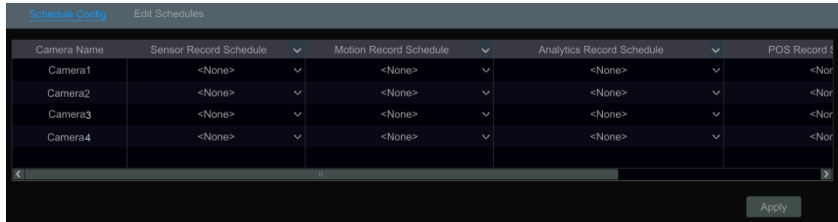
Click Start→Settings→Record→Record Schedule→Schedule Configuration to go to the interface as shown below. Set the schedule of sensor record, motion record, timed record and intelligence record. Click “None” in the drop-down menu to clear the schedule. Click “Apply” to save the settings.



Go to “Edit Schedules” interface and then click  to edit the schedule. The settings of “Edit Schedule” are similar to that of the “Add Schedule”. Click  to delete the schedule.

## 7.4 Record Mode

### 7.4.1 Manual Recording

**Method One:** Click  on the tool bar at the bottom of the live view interface to enable recording of the camera.

**Method Two:** Go to live view interface and then click the right-click menu “Manually Record On” in the camera window or click  on the tool bar under the camera window to start recording.

*Note: Click Start→Settings→Record→Mode Settings and then set the manual record time in the interface. Click “Apply” to save the settings.*

### 7.4.2 Timing Recording

**Timing Recording:** the system will record automatically according to the schedule. Set the timing record schedule of each camera. See [7.3 Schedule Setting](#) for details.

### 7.4.3 Motion Based Recording

**Motion Based Recording:** the system will start motion based recording when the motion object appears in the setup schedule. The setup steps are as follows:

- ① Set the motion based recording schedule of each camera. See [7.3 Schedule Setting](#) for details.
- ② Enable the motion and set the motion area of each camera. See [9.2.1 Motion](#)

Configuration for details.

The camera will start motion based recording once you finish the above settings.

#### 7.4.4 Sensor Based Recording

- ① Set the sensor based recording schedule of each camera. See [7.3 Schedule Setting](#) for details.
- ② Set the NO/NC type of the sensor, enable the sensor alarm and then check and configure the “Record”. See [9.1 Sensor Alarm](#) for details.

#### 7.4.5 Intelligence Recording

- ① Set the intelligence recording schedule of each IP camera. See [7.3 Schedule Setting](#) for details.
- ② Enable the intelligence detection (object detection, exception, line crossing or intrusion detection) and draw alert surface or warning area of each IP camera. See [9.3 Intelligence Alarm](#) for details.

The camera will start intelligence recording once you finish the above settings. This function is only available for some IPCs.

### 7.5 Disk Management

Click Start→Settings→Disk→Disk Management to go to disk management interface. You can view the DVR’s disk number and disk status and so on in the interface. Click the “Format” button to format the HDD.

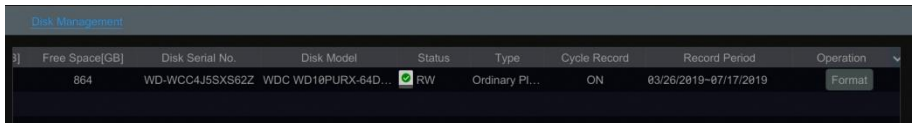

Free Space[GB]	Disk Serial No.	Disk Model	Status	Type	Cycle Record	Record Period	Operation
864	WD-WCCAJ5SXS62Z	WDC WD10PURX-64D...	 RW	Ordinary Pl...	ON	83/26/2019-87/17/2019	Format

*Note: The new HDD should be formatted for normal use.*

#### 7.5.1 Storage Mode Configuration

Click Start→Settings→Disk→Storage Mode to go to the interface as shown below.

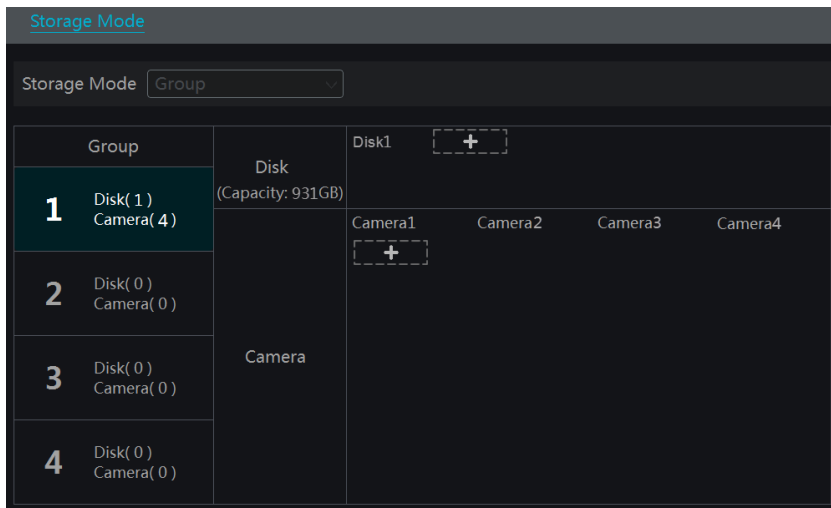

There are four disk groups. By using disk group, you can correspond the camera to disk (the record data of the camera in the group will be stored into the disks in the same group). The DVR with e-SATA interface supports e-SATA recording.

The added disks and cameras will be added into group one automatically. The disks and cameras in the groups can be deleted except group one (select a disk group and then click  on the top right corner of the added disk or camera to delete it from the group). The deleted disks and cameras will be moved into group one automatically.

Each group can add the disks and cameras from other groups. Each disk and camera can only be added into one group. Select a disk group and then click  in the disk or camera row to pop up a window. Check the disks or cameras in the window and then click "Add".

## 7.5.2 View Disk and S.M.A.R.T. Information

Click Start→Settings→Disk→View Disk Information to view the HDD information; click "S.M.A.R.T. Information" to view the working status of the HDD. Refer to the picture below.

Y Disk
Live Display Camera Record Alarm **Disk** Network Account and Authority System X

**Disk Management**

Disk Management

---

**Storage Mode**

Storage Mode Settings

---

**Disk**

View Disk Information >

S.M.A.R.T. Information

Disk **S.M.A.R.T. Information**

Disk Disk2

Disk Serial No. XXX

Disk Model XXX

Temperature 187



Power-on Time (day) 31

S.M.A.R.T. Status Normal

ID	Attribute	Value	Worst Value	Threshold	Raw Value	Status
0x01	Read Error Rate	100	100	62	0	Normal
0x02	Throughput Performance	100	100	40	0	Normal
0x03	Spin-Up Time	234	234	33	1	Normal
0x04	Start/Stop Count	100	100	0	96	Normal
0x05	Reallocated Sector Count	100	100	5	0	Normal
0x07	Seek Error Rate	100	100	67	0	Normal
0x08	Seek Time Performance	100	100	40	0	Normal
0x09	Power-On Hours	99	99	0	724	Normal
0x0a	Spin Retry Count	100	100	60	0	Normal
0x0c	Power Cycle Count	100	100	0	93	Normal
0xbf	G-sense Error Rate	100	100	0	0	Normal
0xc0	Power-off Retract Count	100	100	0	58	Normal
0xc1	Load Cycle Count	100	100	0	8815	Normal
0xc2	Temperature	187	187	0	1638432	Normal
0xc4	Reallocation Event Count	100	100	0	0	Normal
0xc5	Current Pending Sector Count	100	100	0	0	Normal
0xc6	Uncorrectable Sector Count	100	100	0	0	Normal
0xc7	UltraDMA CRC Error Count	200	200	0	0	Normal
0xdf	Load/Unload Retry Count	100	100	0	0	Normal



## 8 Playback & Backup

### 8.1 Instant Playback

Click  on the tool bar at the bottom of the preview camera window to play back the record (click  on the tool bar at the bottom of the live view interface to set the default playback time). Refer to the picture below. Drag the playback progress bar to change the playback time. You can also click the right-click menu “Instant Playback” in the camera window and then set the instant playback time to play back the record.



### 8.2 Playback Interface Introduction



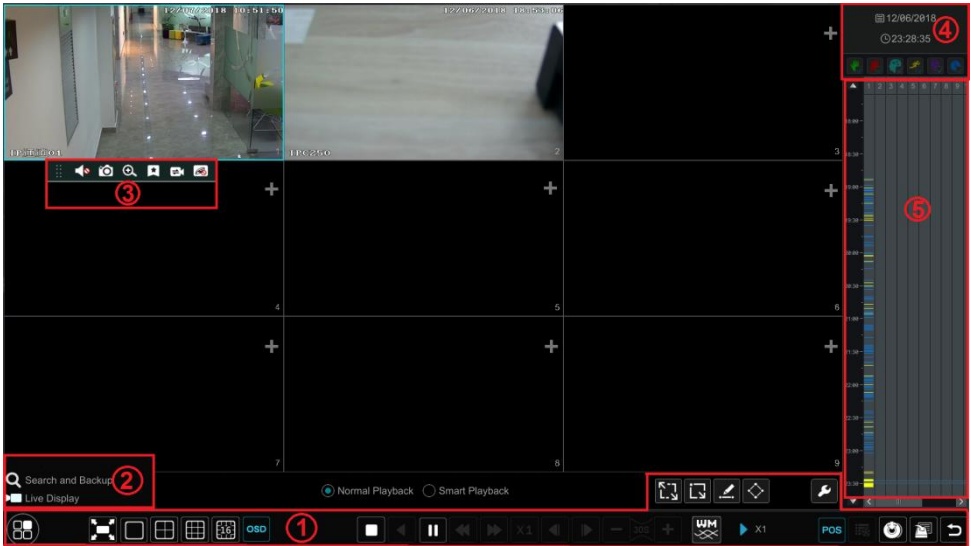











Click  on the tool bar at the bottom of the live view interface or click Start→Playback to go to the playback interface as shown below (click  on the tool bar at the bottom of the live view interface to set the default playback time).



The added cameras will playback their records in the playback interface automatically. You can also add the playback camera manually. Click **+** in the playback window to pop up the “Add Camera” window. Check the cameras in the window and then click “Add” to add playback camera.

The buttons on the tool bar (area ①) at the bottom of the playback interface are introduced in the table below.







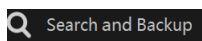
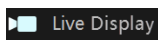

Button	Meaning
	Start button. Click it to pop up area ②.
	Full screen button. Click it to show full screen; click it again to exit the full screen.
	Screen mode button.
	OSD ON button. Click it to enable OSD; click it again to disable OSD.
	Stop button.
	Rewind button. Click it to play video backward.
	Play button. Click it to play video forward.
	Pause button.
	Deceleration button. Click it to decrease the playing speed.
	Acceleration button. Click it to increase the playing speed.
	Previous frame button. It works only when the forward playing is paused in single screen mode.
	Next frame button. It works only when the forward playing is paused in single screen mode.

Button	Meaning
	Click  to step backward 30s and click  to step forward 30s.
	Click it to show the water mark on the image; click  to hide the water mark.
	Event list/tag button. Click it to view the event record of manual/schedule/sensor/ motion and the tag information.
	Open/close POS information.
	Backup button. Drag the mouse on the time scale to select the time periods and cameras, and then click the button to back up the record.
	Backup status button. Click it to view the backup status.
	Back button. Click it to return.
	Full screen motion button.
	Draw rectangle. You can search the record of motion detection in the pre-defined rectangular area.
	Draw line. You can search the record of crossing the line after drawing the line.
	Draw quadrilateral. You can search the record in this quadrilateral after drawing it.
	Smart playback settings. Click it to set smart playback.



Introduction of area ②:

Button	Meaning
	Click it to go to record search interface; see <a href="#">8.4 Record Search, Playback &amp; Backup</a> for details.
	Click it to go to live view interface; see <a href="#">Chapter 5 Live View Introduction</a> for details.











Click on the playback window to show the tool bar as shown in area ③; right click on the window to show the menu list. The tool bar and menu list are introduced in the table below.

Button	Menu List	Meaning
	--	Move tool. Click it to move the tool bar anywhere.
	<b>Enable Audio</b>	Click it to enable audio. You can listen to the camera audio by enabling audio.
	<b>Snap</b>	Click it to snap.
	<b>Zoom In</b>	Click it to go to the zoom in interface. The zoom in interface is similar to that of the camera window in the live view interface. Click  to pause the record playing; click  to play the record. When the record is paused in forward playing mode, you can click  to view the previous frame and click  to view the next frame.







	<b>Add Tag</b>	Click it to add tag. You can play back the record by searching the added tag. Click it and then enter the tag name in the popup window. Click “Add” to add tag.
	<b>Switch Camera</b>	Click it to switch the playback camera. Click it and then check the camera in the popup window. Click “OK” to change the camera.
	<b>Close Camera</b>	Click it to close the playback camera.

Introduction of area ④:

Click  to set the date; click  to set the time and then the playback camera will play the record from the time you set. You can check the record type as required for record playback; first you should click  on the tool bar at the bottom of the interface to clear all the playback camera, then check the record type (: manual record; : sensor based record; : motion based record; : schedule record; : intelligence record; : POS record) and finally click  in the playback window to add camera for playback (the record time scale will show the record data of the checked record type only after the above operations).

Introduction of the record time scale (area ⑤):

A tool bar will appear after moving the mouse to the record time scale. Click  /  to zoom the timeline; click  to recover the timeline to 24 hours' ratio. Drag the timeline or slide the scroll wheel of the mouse on the time scale to show the hidden time on the top or bottom of the timeline. You can also click  to show the hidden time on the top of the timeline or click  to show the hidden time on the bottom of the timeline. Drag the slider at the bottom of the time scale to show the hidden playback cameras.

The record time scale shows different record types with different colors. The green block stands for manual record, red block stands for sensor based record, yellow block stands for motion based record, blue block stands for schedule record and cyan block stands for intelligence record. Click the record block to set the time and then the playback camera will play the record from the time you set.

Drag the color block on the time scale to select the backup area and then right click the area or click  to pop up a backup information window. Click the “Backup” in the window to pop up the backup window. Select the device, backup path and backup format and then click the “Backup” button to start the backup.

## 8.3 Smart Playback

- Smart Playback Settings

Click  to go to the following interface. Set the value of “Speed of non-interest video” (Please skip this one if you click “Skip non-interest video”), “Speed of interest video” and “Intrusion percentage”.

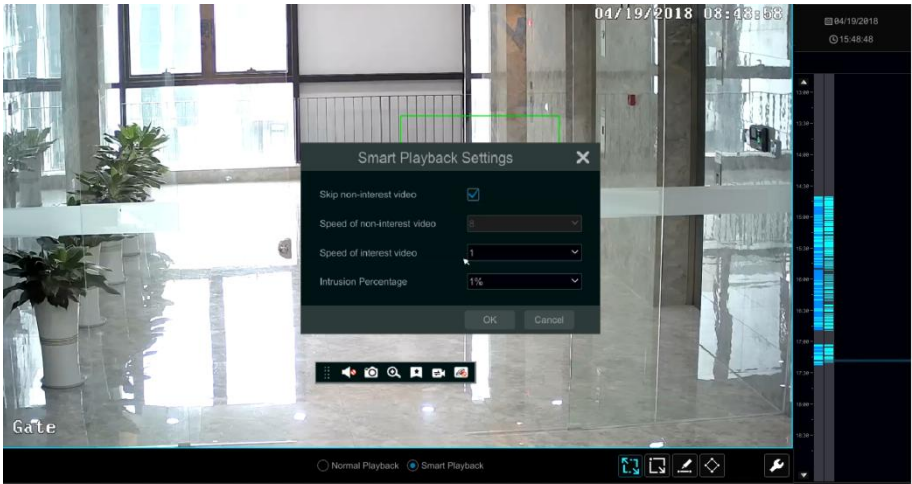

- **Smart Playback by Drawing Rectangle**

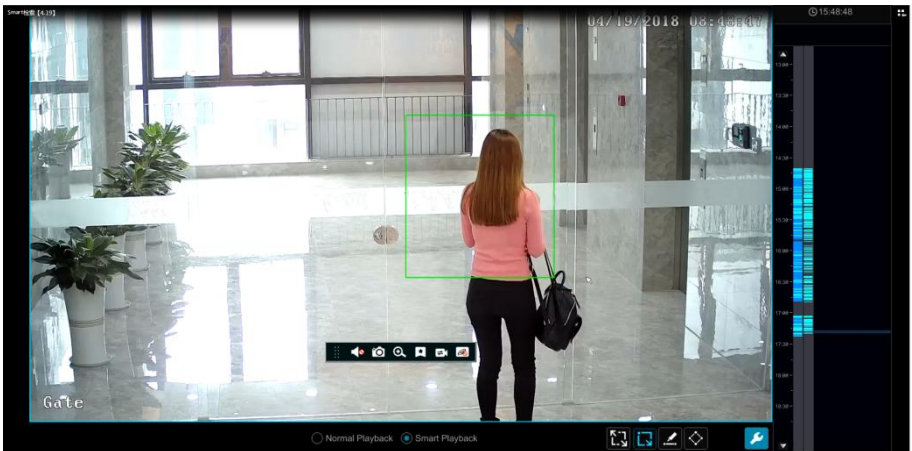

Click  and draw a rectangle in the desired area. Then the system will automatically search the record files of this area. The cyan blocks indicate that there are intelligent recording files. Move the cursor to such block and click to play the record.

- **Smart Playback by Drawing Line**

Click  and draw a line in the desired area. Then the system will automatically search the record files about crossing this line. The cyan blocks indicate that there are intelligent recording files. Move the cursor to such block and click to play the record.



### ● Smart Playback by Drawing Quadrilateral

Click  and draw a quadrangle in the desired area. Then the system will automatically search the record files of this area. The cyan blocks indicate that there are intelligent recording files. Move the cursor to such block and click to play the record.

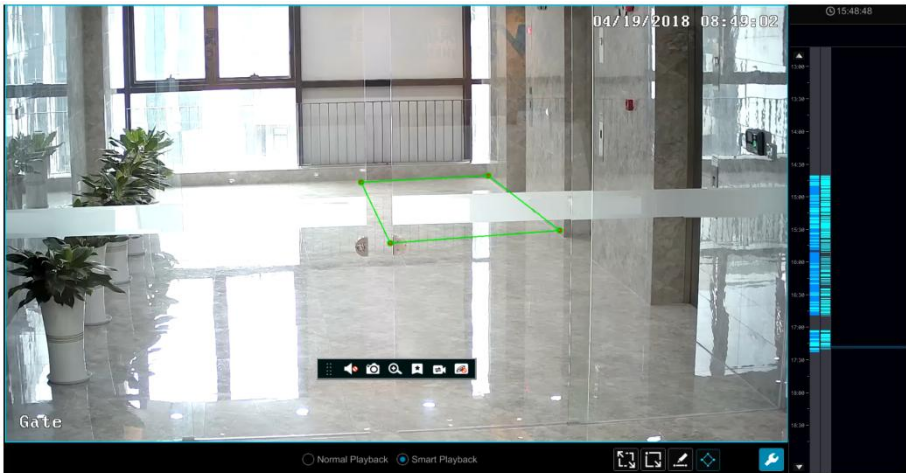

## 8.4 Record Search, Playback & Backup

The record data and the snapped pictures can be backed up through network or USB (U disk or USB mobile HDD). The file system of the backup devices should be FAT32 format.

### 8.4.1 Search, Playback & Backup by Time-sliced Image

- ① Click Start→Search and Backup→By Time-sliced Image to go to “By Time-sliced Image”

tab. There are two view modes: by time and by camera. In the time view mode, a maximum of 64 camera thumbnails can be shown. If the camera thumbnail number is more than 64, the cameras will be listed directly by their camera name, not the thumbnail. A maximum of 196 camera names can be listed. If the camera name number is more than 196, the time view mode will be disabled and the camera view mode will be available only.

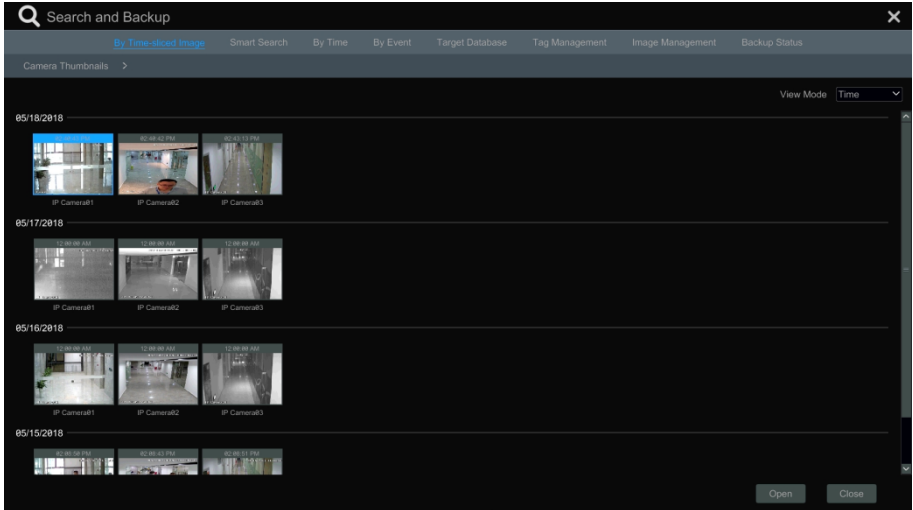

- ② Select one camera in the interface and then click the “Open” button.
- ③ Click the image box to play the record in the small playback box on the left side of the interface (the box which has image inside indicates that the record data exist).
- ④ Refer to the picture below. Drag the color blocks on the time scale to select the record data and then click the “Backup” button to pop up the “Record Backup” window as shown below. Select the device name, backup format and path and then click the “Backup” button to start the backup.

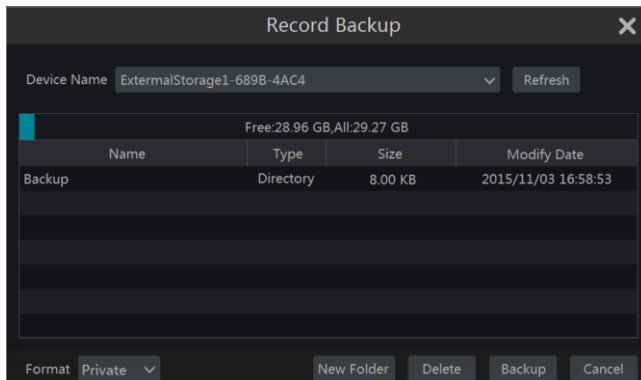

*Note: If you back up the record in private format, the system will back up a RPAS player to USB device automatically. The private format record can be played by RPAS player only.*

- ⑤ Click the “Playback” button to play the record in the playback interface (refer to [8.2 Playback Interface Introduction](#) for details). Click “Close” to close the interface.

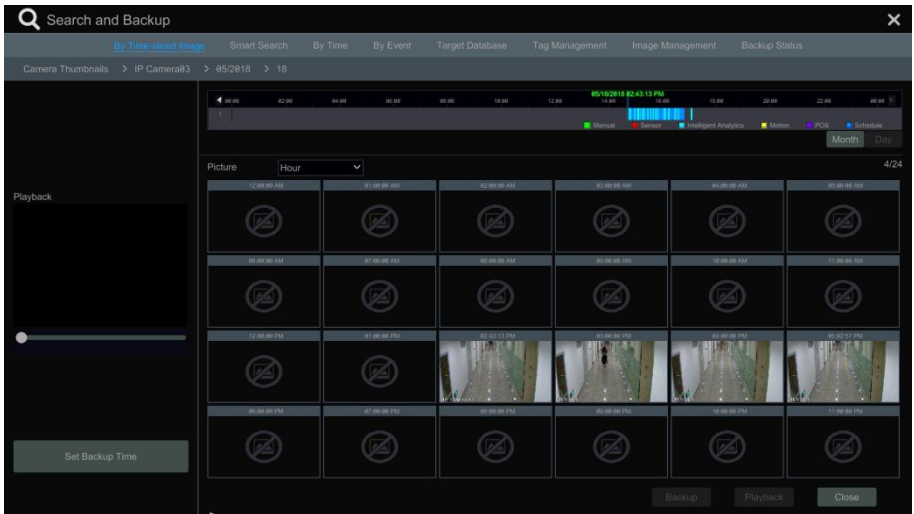

### Time Slice Mode Selecting:

**Method One:** Click the “Year”, “Month” or “Day” button under the record time scale to select the time slice mode. In “Day” mode, click ◀ / ▶ on the left/right side of the time scale to view the record of the last/next day; click “Minute” in the “Picture” option under the time scale to select “Minute” mode (in “Minute” mode, click the time scale to change the time of the 60 display windows) and click “Hour” to select “Hour” mode.

**Method Two:** Click ▶ beside “Camera Thumbnail” on the left top corner of the interface to select the time slice mode.

**Method Three:** Right-click the mouse on any area of the time-sliced interface to go back to the upper interface.

## 8.4.2 Smart Search

- ① Click Start→Search and Backup→Smart Search to go to “Smart Search” tab as shown below.





Behavior Detection: when you select the smart playback mode, the system will analyze the video including the motion detection, tripwire and intrusion detection.

- ② Click “Behavior”. Set the searching time period and you will search the channel which has



the intelligence detection record.

- ③ Check the channel and select the smart playback.
- ④ Set the backup time and select the channel to backup.



-  Smart playback settings button. Click it to set intrusion percentage.
-  Full screen motion button.
-  : Motion button.
-  Draw line button. You can search the record of crossing the line after drawing the line.
-  Draw quadrilateral. You can search the record in this quadrilateral after drawing it.

### 8.4.3 Search, Playback & Backup by Time

- ① Click Start→Search and Backup→By Time to go to “By Time” tab as shown below.
- ② Click  on the bottom of the interface to add playback camera. Click “Modify” on the top right corner of the camera window to change the camera and click “Clear” to remove the camera.
- ③ Click the camera window to play the record in the small playback box on the left side of the interface. You can set the date on the top left of the interface, check the event type as required and click the time scale or click  under the time scale to set the time. The camera window will play the record according to the time and event type you set.
- ④ Drag the color blocks on the time scale to select the record data (or click the “Set Backup Time” button on the bottom left corner of the interface to set the backup start time and end time) and then click the “Backup” button for record backup. Click the “Playback” button to play the record in the playback interface.

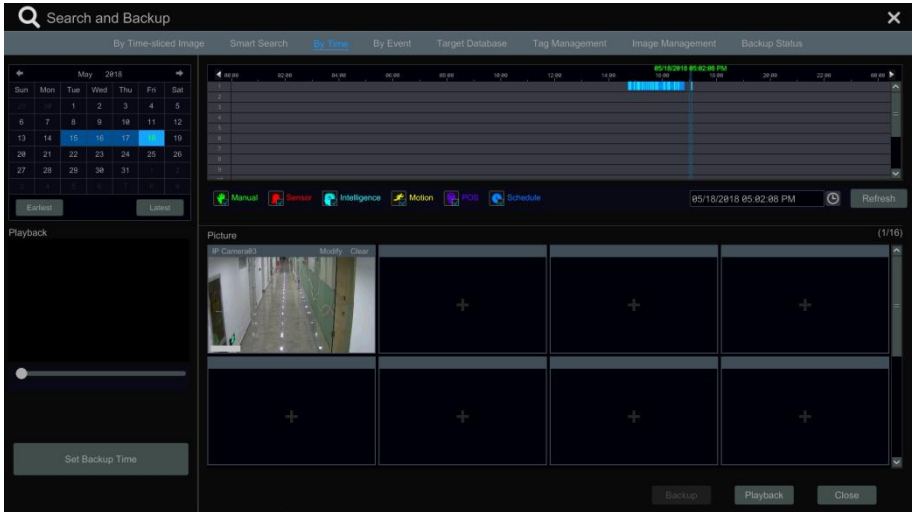

### 8.4.4 Search, Playback & Backup by Event

Some models may support searching POS event.

① Click Start→Search and Backup→By Event to go to “By Event” tab as shown below.

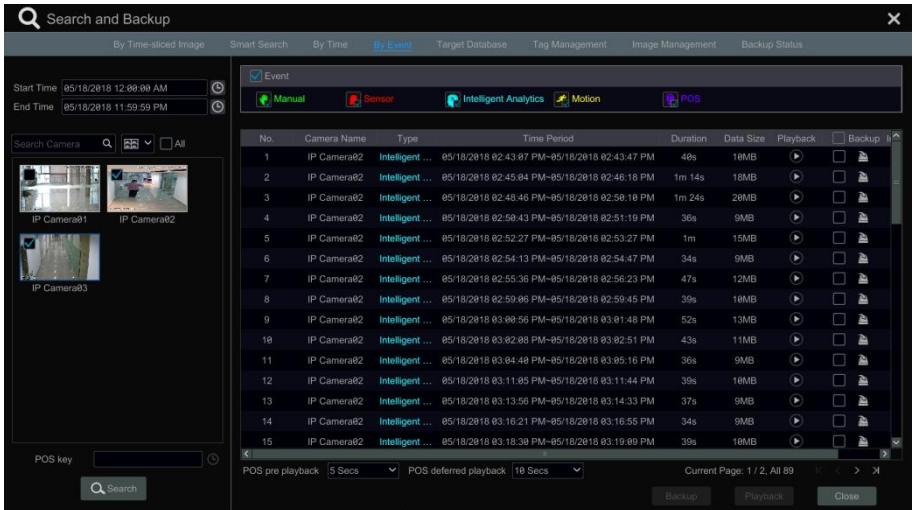

② Check the event type in the interface as required.

③ Click  to set the start time and end time on the top left of the interface.

④ Check cameras on the left side of the interface or check “All” to select all the cameras and then click  to search the record. The searched record will be displayed in the list.

⑤ Click  in the list to play back the record in the popup window. Click  to back up

one record data or check multiple record data in the list and then click the “Backup” button for record batch backup.



⑥ Select one record data in the list and then click the “Playback” button to play the record in the playback interface.

### 8.4.5 Search & Playback by Tag

Only if you add the tags can you play the record by tag search. Click Start→Playback to go to the playback interface and then click  on the bottom of the camera window to add tag when you want to mark the playback time point of the selected camera.

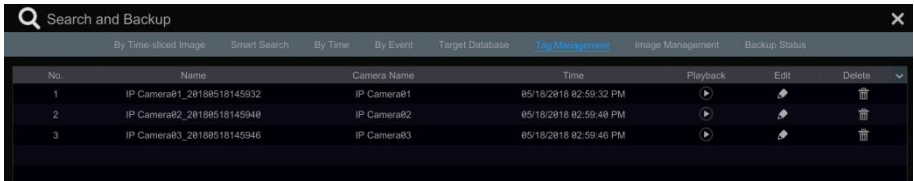
Click Start→Search and Backup→Tag Management to go to “Tag Management” tab.









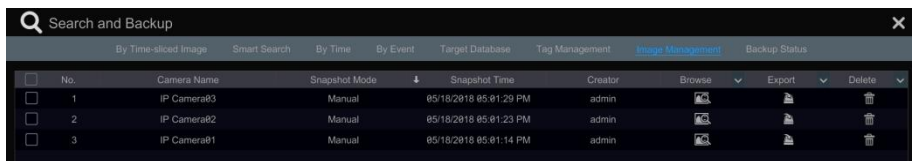

Click  in the interface to play the record. Click  to edit the tag name. Click  to delete the tag.

### 8.4.6 Image Management

Click Start→Search and Backup→Image Management to go to “Image Management” tab. The system will display all the snapped images automatically in the list.



Click  to delete the image. Click  to pop up the “Export” window. Select the device name and save path in the window and then click the “Save” button.

Click  to pop up the “View Image” window. Click  to export the image. Click  to view the previous image; click  to view the next image; click  to delete the image; click  to play all the images.





#### 8.4.7 View Backup Status

Click Start→Search and Backup→Backup Status or click  on the tool bar at the bottom of the playback interface to view the backup status.

# 9 Alarm Management

## 9.1 Sensor Alarm

To complete the entire sensor alarm settings, you should enable the sensor alarm of each camera and then set up the alarm handling of each camera.

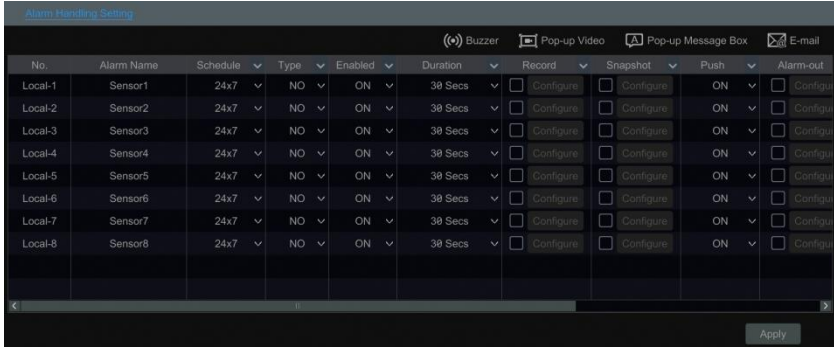

- ① Click Start→Settings→Alarm→Sensor Alarm to go to the following interface.



- ② Select the alarm type (NO or NC) according to trigger type of the sensor.
- ③ Enable the sensor alarm of each camera.
- ④ Check the “Record”, “Snapshot”, “Push”, “Alarm-out” and “Preset” and enable or disable the “Buzzer”, “Pop-up Video”, “Pop-up Message Box” and “E-mail” as required.
- ⑤ Click “Apply” to save the settings.

The configuration steps of the above mentioned alarm linkages are as follows.

**Duration:** it refers to the interval time between the adjacent motion detections. For instance, if the duration time is set to 10 seconds, once the system detects a motion, it will go to alarm and would not detect any other motion (specific to camera) in 10 seconds. If there is another motion detected during this period, it will be considered as a continuous movement; otherwise it will be considered as a single motion.

**Record:** check it and then the “Trigger Record” window will pop up automatically (you can also click the “Configure” button to pop up the window). Select camera on the left side and then click  to set the camera as the trigger camera. Select trigger camera on the right side and then click  to cancel the trigger camera. Click the “OK” button to save the settings. The trigger cameras will record automatically when the sensor alarm is triggered.

**Snapshot:** check it and then the “Trigger Snapshot” window will pop up automatically. Configure the trigger camera in the window. The trigger cameras will snap automatically when the sensor alarm is triggered.

**Push:** check it and choose ON or OFF. If it is ON, the system will send messages when the sensor alarm is triggered.

**Alarm-out:** check it and then the “Trigger Alarm-out” window will pop up automatically. Configure the trigger alarm-out in the window. The system will trigger the alarm-out

automatically when the sensor alarm is triggered. You need to set the delay time and the schedule of the alarm outputs. See [9.5.1 Alarm-out](#) for details.

**Preset:** check it and then the “Trigger Preset” window will pop up automatically. Configure the trigger preset of each camera. To add presets, please see [6.2 Preset Setting](#) for details.

**Buzzer:** if enabled, the system will begin to buzz when the sensor alarm is triggered. To set the delay time of the buzzer, please see [9.5.4 Buzzer](#) for details.

**Pop-up Video:** After camera setting, the system will pop up the corresponding video automatically when the sensor alarm is triggered. To set the duration time of the video, please see [9.5.3 Display](#) for details.

**Pop-up Message Box:** if enabled, the system will pop up the corresponding alarm message box automatically when the sensor alarm is triggered. To set the duration time of the message box, please see [9.5.3 Display](#) for details.

**E-mail:** if enabled, the system will send an e-mail when the sensor alarm is triggered. Before you enable the email, please configure the recipient’s e-mail address first (see [11.1.5 E-mail Configuration](#) for details).

## 9.2 Motion Alarm

**Motion Alarm:** when the motion object appears in the specified area, it will trigger the alarm. You should enable the motion of each camera first and then set the alarm handling of the camera to complete the whole configuration of the motion alarm.

### 9.2.1 Motion Configuration

- ① Click Start→Settings→Camera→Motion to go to the following interface.

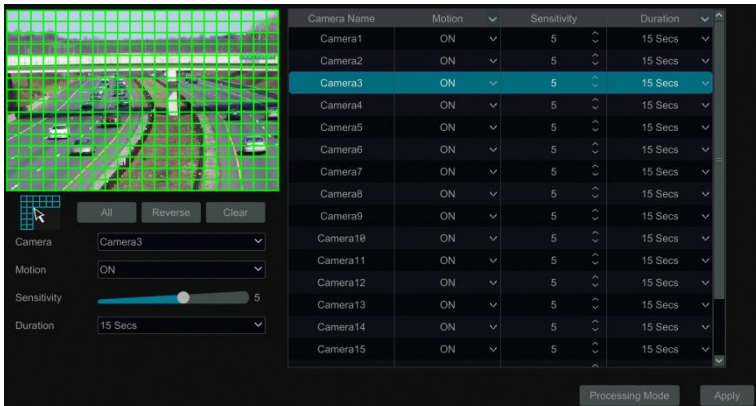

- ② Select the camera, enable the motion and set the sensitivity and duration of the camera.

**Sensitivity:** the higher the value is, the more sensitive it is to motion. You should adjust the value according to the practical conditions since the sensitivity is influenced by color and time (day or night).

**Duration:** it refers to the interval time between the adjacent motion detections. For instance, if

the duration time is set to 10 seconds, once the system detects a motion, it will go to alarm and would not detect any other motion (specific to camera) in 10 seconds. If there is another motion detected during this period, it will be considered as a continuous movement; otherwise it will be considered as a single motion.

- ③ Drag the camera image to set the motion area. You can set more than one motion area. Click “All” to set the whole camera image as the motion area. Click “Reverse” to swap the motion area and the non-motion area. Click “Clear” to clear all the motion areas.
- ④ Click “Apply” to save the settings. Click “Processing Mode” to go to the alarm handling configuration interface of the motion alarm.

## 9.2.2 Motion Alarm Handling Configuration

- ① Click Start→Settings→Alarm→Motion Alarm to go to the following interface.

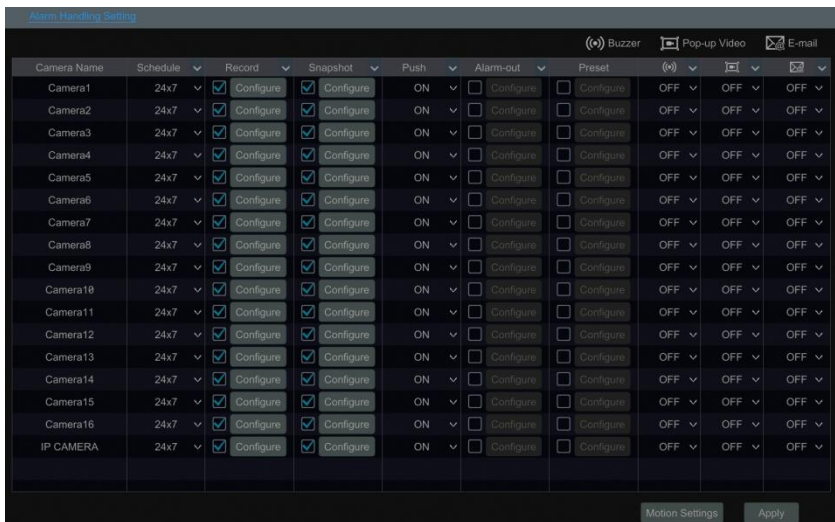

- ② Enable or disable “Record”, “Snapshot”, “Push”, “Alarm-out”, “Preset”, “Buzzer”, “Pop-up Video” and “E-mail”. The alarm handling setting of motion alarm is similar to that of the sensor alarm (see [9.1 Sensor Alarm](#) for details).
- ③ Click “Apply” to save the settings. You can click “Motion Settings” to go to the motion configuration interface.

## 9.3 Intelligence Alarm

### 9.3.1 Object Detection

#### Object Detection Configuration:

- ① Click Start→Settings→Camera→Intelligent Analytics→Object Detection to go to the following interface.
- ② Select the camera, enable the object detection and set the duration and detect type. There

are two detect types: Abandoned object and missing object.

**Abandoned object:** Alarms will be triggered if there are articles left in the pre-defined detection area.

**Missing object:** Alarms will be triggered if there are articles missing in the detection area drawn by the users.

- ③ Select the alarm area. A maximum of 4 alarm areas can be set.
- ④ Draw the alarm area of the object detection. Refer to the interface as shown above. Check “Draw Area” and then click around the area where you want to set as the alarm area in the image (the alarm area should be a closed area). Uncheck the “Draw Area” if you finish the drawing. Click the “Clear” button to delete the alarm area.
- ⑤ Click “Apply” to save the settings.
- ⑥ Click “Processing Mode” to go to the alarm handling configuration interface of object detection.

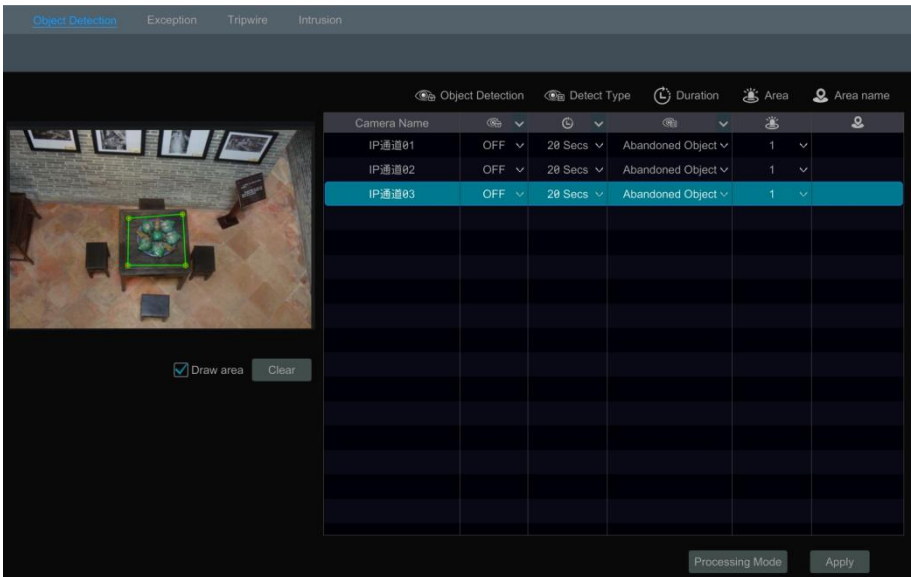

### Object Detection Alarm Handling Configuration:

- ① Click Start→Settings→Alarm→Intelligence Alarm→Object Detection to go to the following interface.

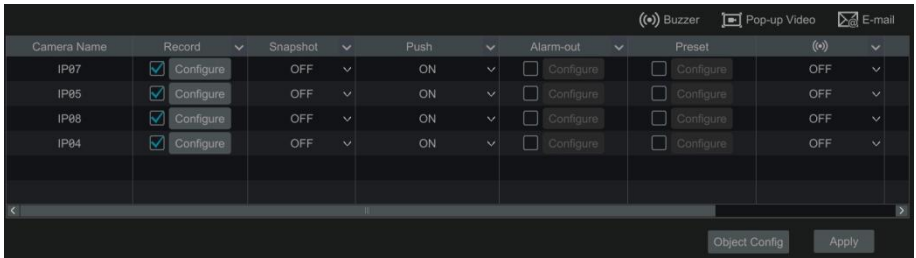

② Enable or disable “Record”, “Snapshot”, “Push”, “Alarm-out”, “Preset”, “Buzzer”, “Pop-up Video” and “E-mail”. The alarm handling setting of object detection alarm is similar to that of the sensor alarm (see [9.1 Sensor Alarm](#) for details).

③ Click “Apply” to save the settings. You can click “Object Config” to go to the object detection configuration interface.

### 9.3.2 Exception

#### Exception Configuration:

① Click Start→Settings→Camera→Intelligent Detection→Exception to go to the following interface.

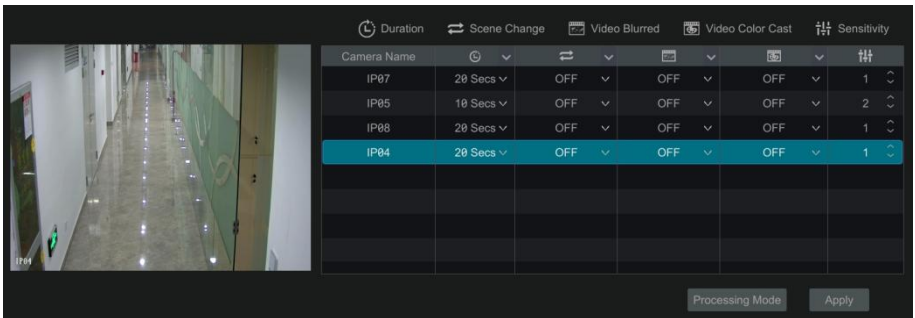

② Select the camera and enable the relevant detection as needed.

**Scene Change:** Alarms will be triggered if the scene of the monitor video has changed.

**Video Blurred:** Alarms will be triggered if the video becomes blurry.

**Video Color Cast:** Alarms will be triggered if the video becomes obscured.

③ Set the sensitivity of the exception detection.

④ Click “Apply” to save the settings.

⑤ Click “Processing Mode” to go to the alarm handling configuration interface of exception detection.

#### Exception Alarm Handling Configuration:

① Click Start→Settings→Alarm→Intelligence Alarm→Exception to go to the interface.

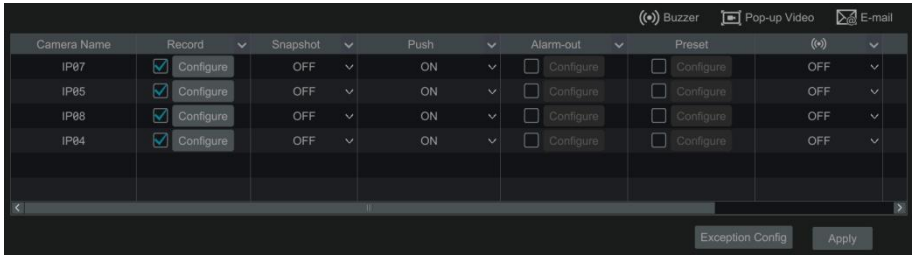

② Enable or disable “Record”, “Snapshot”, “Push”, “Alarm-out”, “Preset”, “Buzzer”, “Pop-up Video” and “E-mail”. The alarm handling setting of exception detection alarm is similar to that of the sensor alarm (see [9.1 Sensor Alarm](#) for details).

③ Click “Apply” to save the settings. You can click “Exception Config” to go to the exception detection configuration interface.

### 9.3.3 Tripwire

#### Tripwire/Line Crossing Configuration:

Alarms will be triggered if someone or something crosses the pre-defined alarm line.

① Click Start→Settings→Camera→Intelligent Detection→Tripwire to go to the following interface.

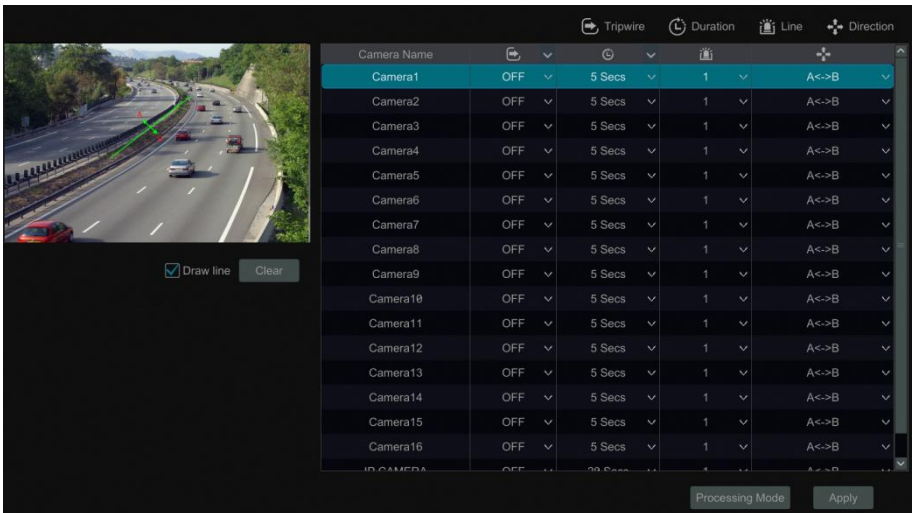

② Select the camera, enable the line crossing detection and set the duration.

③ Select the direction.

**Direction:** A<->B, A->B and A-<B optional. It is the crossing direction of the intruder who crosses over the alert line.

**A<->B:** the alarm triggers when the intruder crosses over the alert line from B to A or from A to B.

**A->B:** the alarm triggers when the intruder crosses over the alert line from A to B.

**A<-B:** the alarm triggers when the intruder crosses over the alert line from B to A.

④ Draw line. Refer to the interface as shown above. Check “Draw line” and then drag the mouse in the image to draw an alert line. Uncheck the “Draw line” if you finish the drawing. Click the “Clear” button to delete the alert line.

⑤ Click “Apply” to save the settings.

⑥ Click “Processing Mode” to go to the alarm handling configuration interface of line crossing detection.

### Line Crossing Alarm Handling Configuration:

① Click Start→Settings→Alarm→Intelligence Alarm→Line Crossing to go to the following interface.

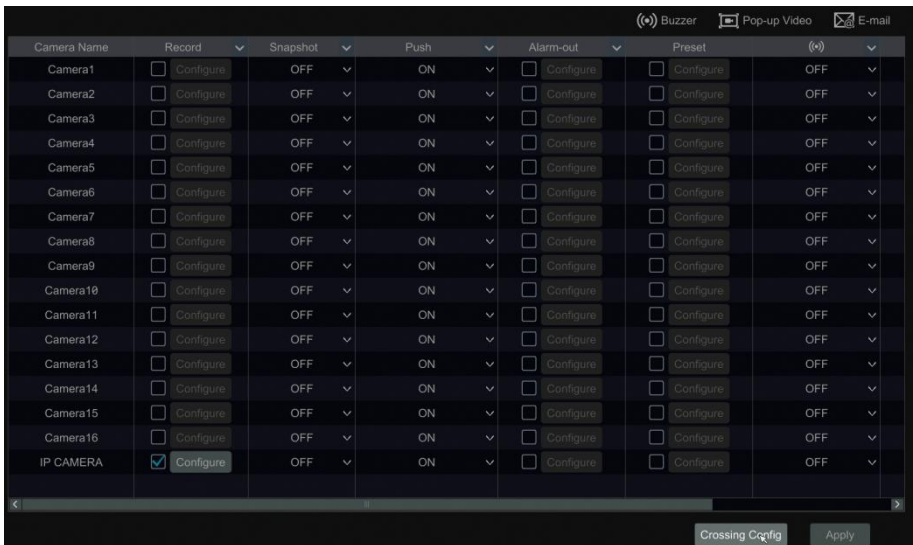

② Enable or disable “Record”, “Snapshot”, “Push”, “Alarm-out”, “Preset”, “Buzzer”, “Pop-up Video” and “E-mail”. The alarm handling setting of line crossing alarm is similar to that of the sensor alarm (see [9.1 Sensor Alarm](#) for details).

③ Click “Apply” to save the settings. You can click “Crossing Config” to go to the line crossing configuration interface.

## 9.3.4 Intrusion Detection

### Intrusion Configuration:

Alarms will be triggered if someone or something intrudes into the pre-defined area.

① Click Start→Settings→Camera→Intelligent Detection→Intrusion Detection to go to the following interface.

② Select the camera, enable the intrusion detection and set the duration.



- ③ Select the alarm area. Up to 4 alarm areas can be set up.
- ④ Draw the alarm area of the intrusion detection. Refer to the interface as shown below. Check “Draw Area” and then click around the area where you want to set as the alarm area in the image (the alarm area should be a closed area). Uncheck the “Draw Area” if you finish the drawing. Click the “Clear” button to delete the alarm area.
- ⑤ Click “Apply” to save the settings.
- ⑥ Click “Processing Mode” to go to the alarm handling configuration interface of intrusion detection.

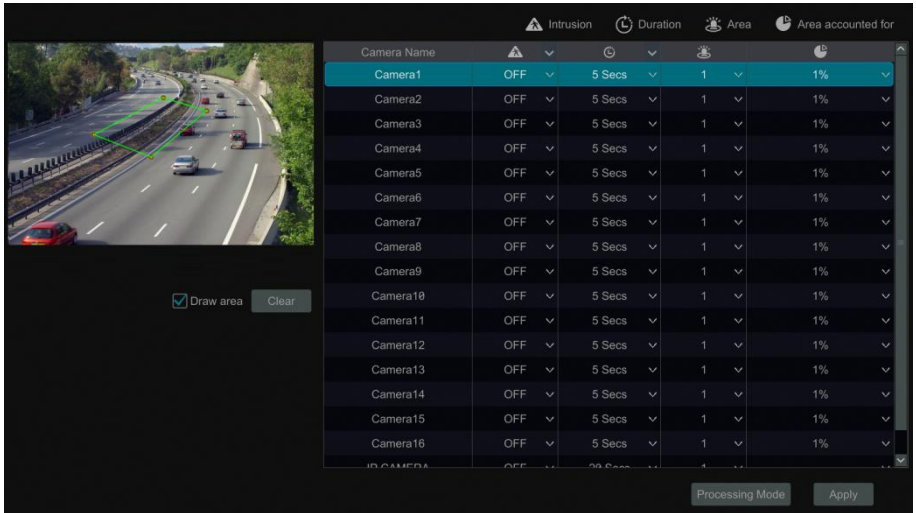

### Intrusion Detection Alarm Handling Configuration:

- ① Click Start→Settings→Alarm→Intelligence Alarm→Intrusion Detection to go to the following interface.

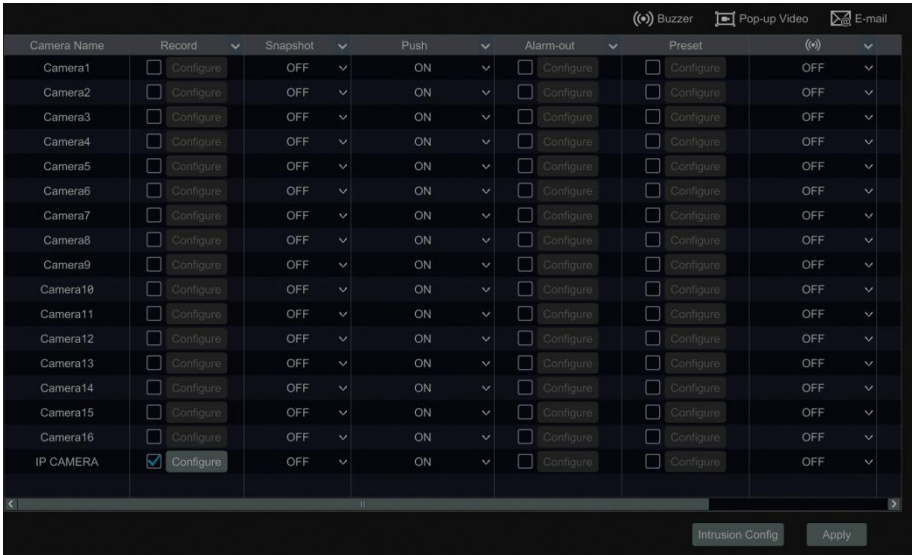

② Enable or disable “Record”, “Snapshot”, “Push”, “Alarm-out”, “Preset”, “Buzzer”, “Pop-up Video” and “E-mail”. The alarm handling setting of intrusion detection alarm is similar to that of the sensor alarm (see [9.1 Sensor Alarm](#) for details).

③ Click “Apply” to save the settings. You can click “Intrusion Config” to go to the intrusion detection configuration interface.

## 9.4 Exception Alarm

### 9.4.1 IPC Offline Settings

① Click Start→Settings→Alarm→Exception→IPC Offline Settings to go to the interface as shown below.

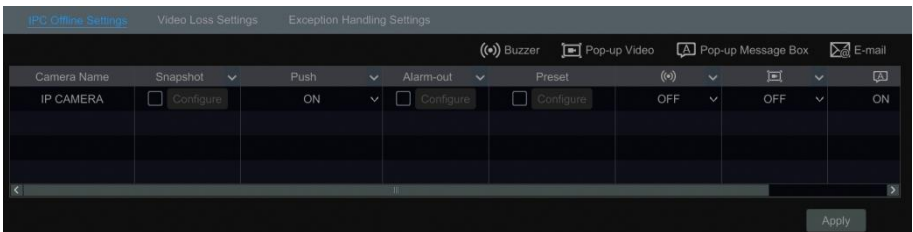

② Enable or disable “Snapshot”, “Push”, “Alarm-out”, “Preset”, “Buzzer”, “Pop-up Video”, “Pop-up Message Box” and “E-mail”. The IPC Offline Settings are similar to that of the sensor alarm (see [9.1 Sensor Alarm](#) for details).

③ Click “Apply” to save the settings.

## 9.4.2 Video Loss Settings

- ① Click Start→Settings→Alarm→Exception→Video Loss Settings to go to the interface as shown below.

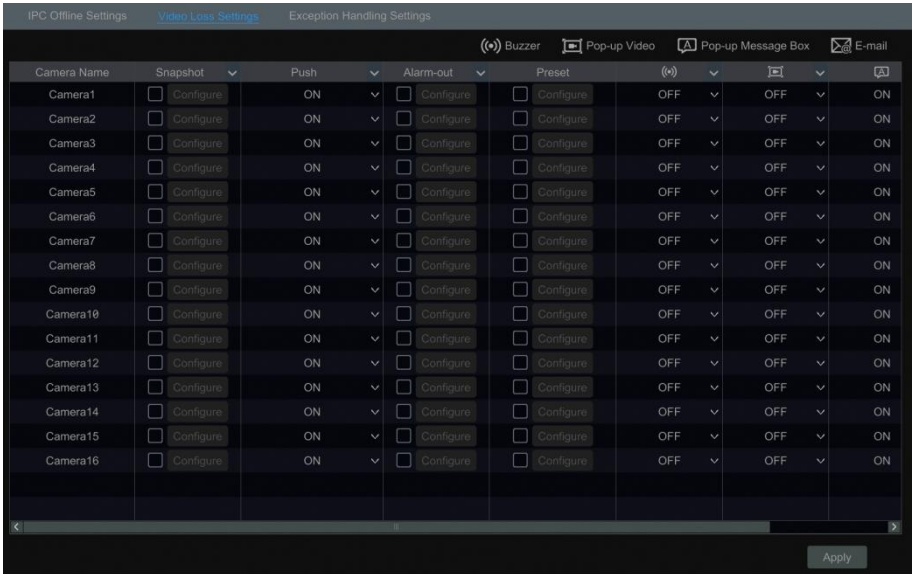

- ② Enable or disable “Record”, “Snapshot”, “Push”, “Alarm-out”, “Preset”, “Buzzer”, “Pop-up Video”, “Pop-up Message Box” and “E-mail”. The Video Loss Settings are similar to that of the sensor alarm (see [9.1 Sensor Alarm](#) for details).
- ③ Click “Apply” to save the settings.

## 9.4.3 Exception Handling Settings

- ① Click Start→Settings→Alarm→Exception→Exception Handling Settings to go to the interface as shown below.
- ② Enable or disable “Alarm-out”, “Buzzer”, “Pop-up Message Box” and “E-mail”. The exception handling settings are similar to that of the sensor alarm (see [9.1 Sensor Alarm](#) for details).
- ③ Click “Apply” to save the settings.

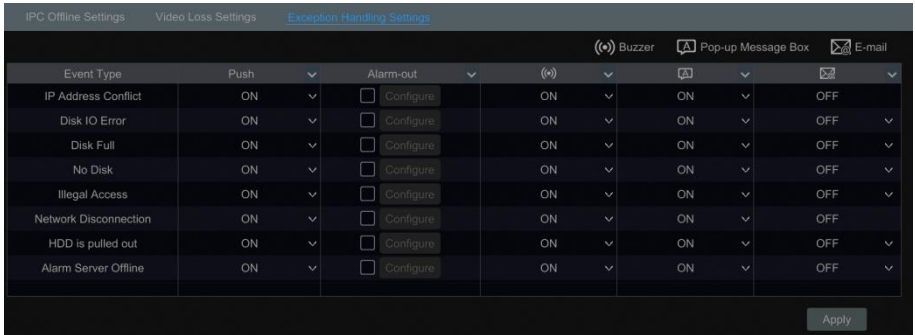

## 9.5 Alarm Event Notification

### 9.5.1 Alarm-out

- ① Click Start→Settings→Alarm→Event Notification to go to the following interface.

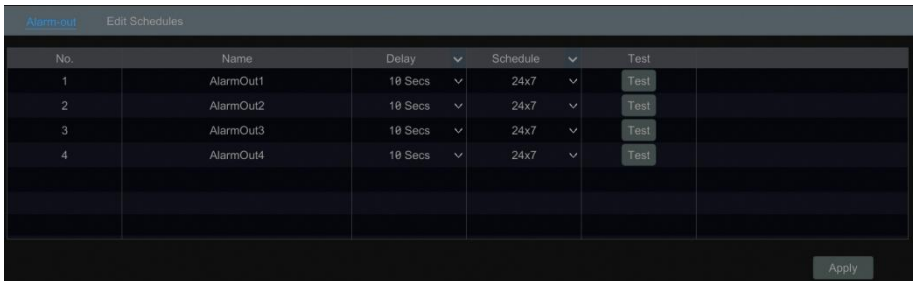

- ② Set the delay time and the schedule of each alarm-out. You can click “Edit Schedules” to edit the schedules (see [7.3.1 Add Schedule](#) for details).
- ③ Click “Apply” to save the settings. You can click “Test” to test the alarm output.

### 9.5.2 E-mail

Click Start→Settings→Alarm→Event Notification→E-mail to go to the e-mail configuration interface. Set the e-mail address of the recipients. See [11.1.5 E-mail Configuration](#) for details.

### 9.5.3 Display

Click Start→Settings→Alarm→Event Notification→Display to go to the display configuration interface. Set the duration time of the pop-up video and the pop-up message box. Click “Apply” to save the settings.

The screenshot shows two sections of the alarm configuration interface. The top section, titled "Pop-up Video", has a "Duration" dropdown menu set to "10 Secs". The bottom section, titled "Pop-up Message Box", has a checkbox labeled "Don't show later" which is unchecked, and a "Duration" dropdown menu set to "10 Secs". An "Apply" button is located at the bottom right of the interface.

### 9.5.4 Buzzer

Click Start→Settings→Alarm→Event Notification→Buzzer to go to the buzzer configuration interface. Set the delay time of the buzzer and then click “Apply” to save the setting. You can click “Test” to test the buzzer.

The screenshot shows the "Buzzer" configuration interface. It features a "Delay" dropdown menu set to "5 Secs". At the bottom, there are two buttons: "Test" and "Apply".

### 9.5.5 Push Message

Click Start→Settings→Alarm→Event Notification→Push Message to go to the interface as shown below. Check “Enable”, choose the push schedule and then click the “Apply” button to save the settings. If Push Server is online, it will push messages to the mobile clients.

The screenshot shows the "Push Message" configuration interface. It has a checked checkbox for "Enable", a "Push Schedule" dropdown menu set to "24x7", and a "Push Server Status" indicator showing "Disabled". At the bottom, there are "Test" and "Apply" buttons.

### 9.5.6 Alarm Server

Go to Alarm→Alarm Server interface as shown below.

Enable the alarm server and enter server address and port of the alarm server. Then select protocol. If “Send Heartbeat” is enabled, set the interval times. After that, test the effectiveness of the alarm server. Having tested successfully, please click “Apply”. When an alarm occurs,

the device will transfer the alarm event to the alarm server. If an alarm server is not needed, there is no need to configure this section.

Alarm Server

Enable

Server Address

Port

Protocol

Send Heartbeat

Interval Time[s]:

Test Apply

## 9.6 Manual Alarm

Click  on the tool bar at the bottom of the live view interface to pop up a window. Click “Trigger” to start alarm. Click “Clear” to stop alarm.

Alarm-out Name	Status	Trigger	Clear	
AlarmOut1	Normal	Trigger	Clear	▼

Close

## 9.7 View Alarm Status

Click Start→Settings→Alarm→Alarm Status or click  on the tool bar at the bottom of the live view interface to view the alarm status.

Alarm Status

Buzzer

Alarm-in  Normal

Alarm-out  Normal

Motion  Normal





Intelligence  Normal

Exception  Normal

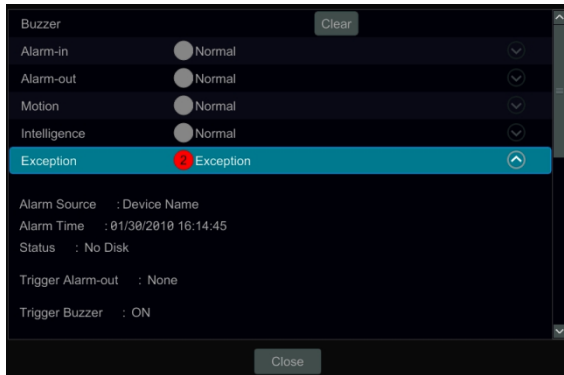
Combination Alarm  Normal

Click the “Clear” button to stop the buzzer when the buzzer alarm happens. Click  to view the detail information as shown below.



If the exception information is more than one page, you can enter the number in the box and then click  to jump to the specified page. Click  /  to view the exception alarm information in the previous/next page. Click  to play the alarm record.

# 10 Account & Permission Management

## 10.1 Account Management

Click Start→Settings→Account and Authority→Account→Edit User to go to the interface as shown below.

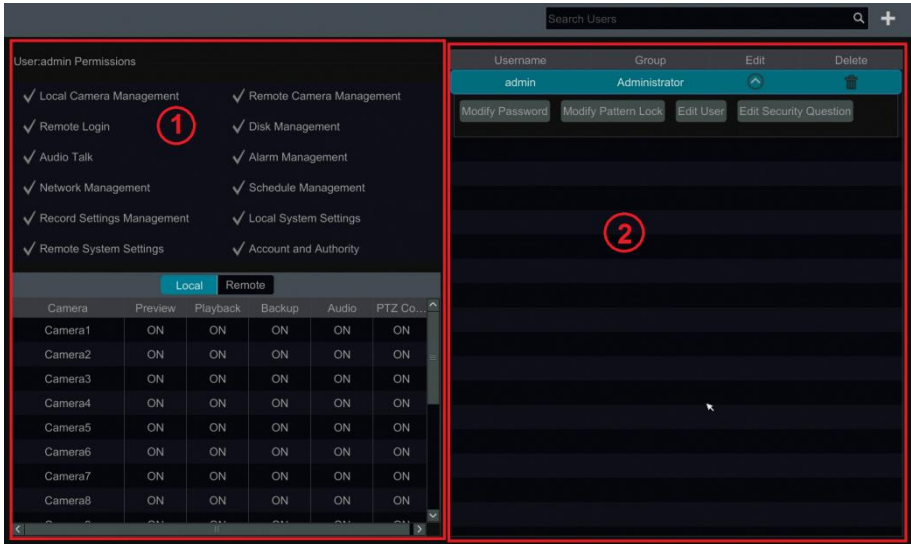

Area ① displays the user permissions. Area ② displays the user list. Click the user in the list to display its user permissions in area ①.

There are three default permission groups (“Administrator”, “Advanced” and “Common”) available when adding accounts. You can manually add new permission group (see [10.3.1 Add Permission Group](#) for details).

Only **admin** and the users that have the “Account and Authority” permission can manage the system’s accounts. Group “Administrator” owns all the permissions displayed in area ① except “Account and Authority” and its permissions cannot be changed while the permissions of “Advanced” and “Common” can be changed.



### 10.1.1 Add User

① Click Start→Settings→Account and Authority→Account→Add User or click  beside the search box to pop up the window as shown below.



② Set the username, password and group. The e-mail address and MAC address are optional (enter the MAC address after you check it). Click “Add” to add the user.

## 10.1.2 Edit User

Click Start→Settings→Account and Authority→Account→Edit User and then click  in the user list or double click the user to edit the user information. Click  to delete the user (the user *admin* cannot be deleted).

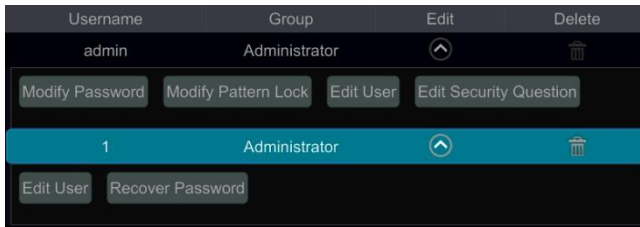

### ➤ Edit Security Question

You can set password security only for *admin*. Click “Edit Security Question” and then set questions and answers in the popup window. If you forget the password for *admin*, please refer to Q4 in [Appendix A FAQ](#) for details. The passwords of other users can be recovered by *admin* or the users that have the “Account and Authority” permission.

### ➤ Modify Password

Only the password of *admin* can be modified. Click “Modify Password” to pop up a window. Enter the current password and then set new password. Click “OK” to save the settings.

### ➤ Modify Pattern Lock

Some models may not support this function.

Click “Modify Pattern Lock” to pop up a window.

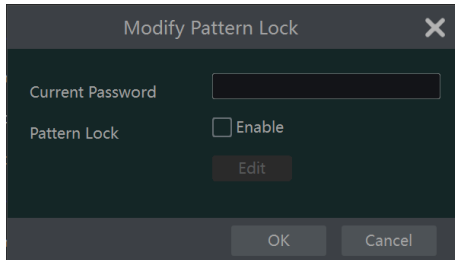

Enter the current password and then check “Enable” to set pattern lock.

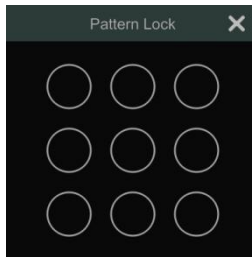

➤ **Recover Password**

Click “Recover Password” to reset the password to **123456**.

➤ **Edit User**

Click “Edit User” to pop up the window as shown below. The **admin** is enabled, its permission control is closed and permission group cannot be changed by default. You can enable or disable other users (if disabled, the user will be invalid), open or close their permission control (if closed, the user will get all the permissions which **admin** has) and set their permission groups. Click “OK” to save the settings.

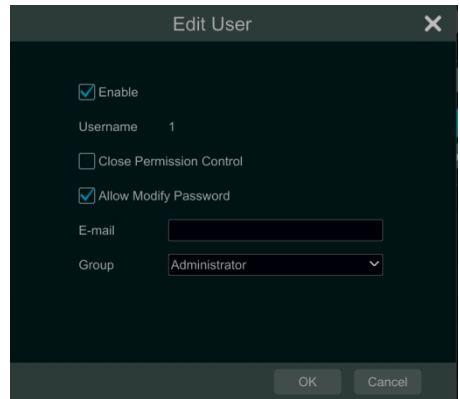
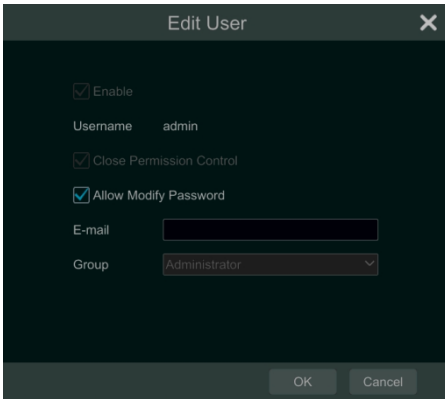

## 10.2 User Login & Logout

**Login:** Click Start→Login or directly click the preview interface and then select username and enter the password in the popup window. Click the “Login” button to log in the system.

**Logout:** Click Start→Logout or click Start→Shutdown to pop up the “Shutdown” window. Select “Logout” in the window and then click “OK” to log out the system.

## 10.3 Permission Management

### 10.3.1 Add Permission Group

Click Start→Settings→Account and Authority→Account→Edit Permission Group to go to the interface as shown below.

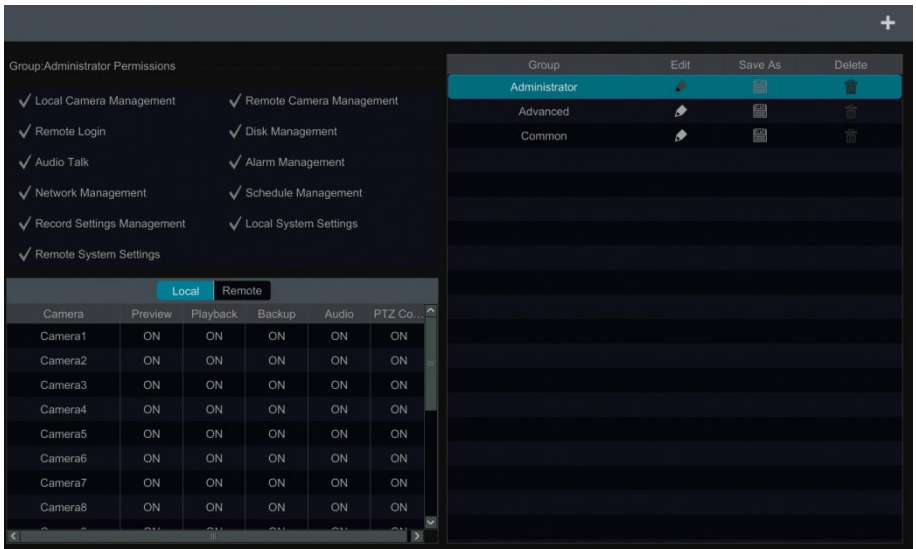

Click  to add permission group. Set the group name, check the permissions as required and then set the “Local” and “Remote” permissions. Click “Add” to save the settings.

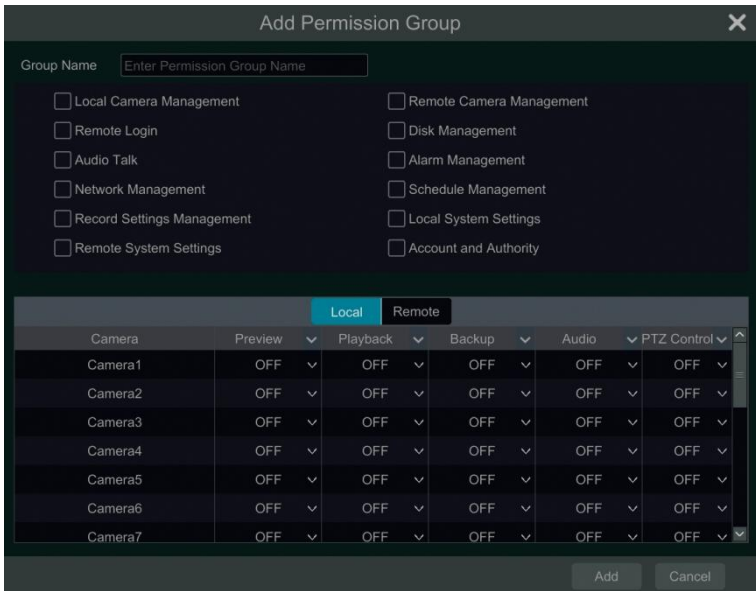

The screenshot shows the 'Add Permission Group' dialog box. At the top, there is a text input field for 'Group Name' with the placeholder text 'Enter Permission Group Name'. Below this, there are two columns of checkboxes for permissions:



- Local Camera Management
- Remote Camera Management
- Remote Login
- Disk Management
- Audio Talk
- Alarm Management
- Network Management
- Schedule Management
- Record Settings Management
- Local System Settings
- Remote System Settings
- Account and Authority

Below the checkboxes, there are two tabs: 'Local' (selected) and 'Remote'. Under the 'Local' tab, there is a table with the following columns: Camera, Preview, Playback, Backup, Audio, and PTZ Control. The rows represent cameras from Camera1 to Camera7. All permissions in the table are currently set to 'OFF'.

Camera	Preview	Playback	Backup	Audio	PTZ Control
Camera1	OFF	OFF	OFF	OFF	OFF
Camera2	OFF	OFF	OFF	OFF	OFF
Camera3	OFF	OFF	OFF	OFF	OFF
Camera4	OFF	OFF	OFF	OFF	OFF
Camera5	OFF	OFF	OFF	OFF	OFF
Camera6	OFF	OFF	OFF	OFF	OFF
Camera7	OFF	OFF	OFF	OFF	OFF

At the bottom right of the dialog, there are 'Add' and 'Cancel' buttons.



### 10.3.2 Edit Permission Group

Go to “Edit Permission Group” interface and then click  in the group list to edit the permission group (the operations of the “Edit Permission Group” are similar to that of the “Add Permission Group”, please see [10.3.1 Add Permission Group](#) for details). Click  to save the group as another group. Click  to delete the permission group. The three default permission groups (“Administrator”, “Advanced” and “Common”) cannot be deleted.

## 10.4 Black and White List

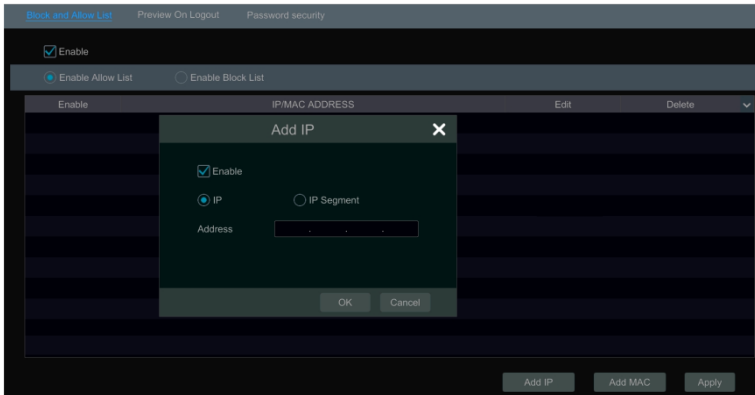
- ① Click Start→Settings→Account and Authority→Security to go to the following interface.



- ② Check “Enable” and then choose “Enable Allow List (white list)” or “Enable Block List (black list)” (the PC client of which the IP address is in the allow list can access DVR remotely while the PC client in the block list cannot).
- ③ Add IP/IP segment/MAC. Click “Add IP” or “Add MAC” and then check “Enable” in the popup window (only if you check it can the IP/IP segment/MAC you add be effective). Enter the IP/IP segment/MAC and then click “OK”. In the above interface, click  to edit IP/IP segment/MAC, click  to delete it. Click “Apply” to save the settings.

## 10.5 Preview On Logout

Click Start→Settings→Account and Authority→Security→Preview On Logout to go to the following interface.

Set a camera and then enable or disable the preview permission on logout as required. If a camera’s preview permission on logout is “ON”, you can view the live image of the camera when the system is logged out, or the live image of the camera cannot be seen when logged out.

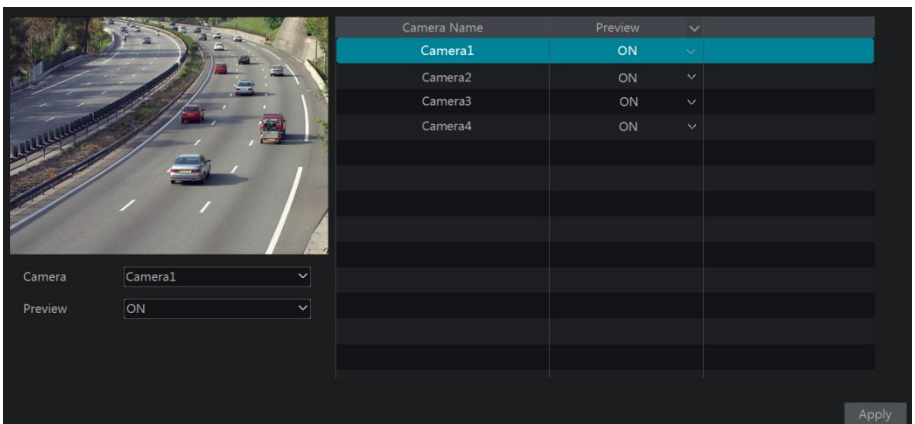

## 10.6 Password Security

Click Start→Settings→Account and Authority→Security→Password Security to go to the following interface.



In this interface, you can set the level and expiration time of the password.

## 10.7 View Online User

Click Start→Settings→Account and Authority→User Status to view the online user information (you can view the online user name, login type, IP address and login time; click  to pop up a window showing the preview occupied channel number and playback occupied channel number).

# 11 Device Management

## 11.1 Network Configuration

### 11.1.1 TCP/IP Configuration

Click Start→Settings→Network→TCP/IP to go to the following interface. Check “Obtain an IPv4 address automatically”, “Obtain an IPv6 address automatically” and “Obtain DNS automatically” to get the network addresses automatically, or manually enter the network addresses. You can modify the MTU value according to the network condition (MTU, Maximum Transmission Unit, can be modified according to network condition for higher network transmission efficiency). Click “Apply” to save the settings.

IP Address Settings

Ethernet Port 1 ( Online )

Obtain an IPv4 address automatically

Address: 19 . 19 . 7 . 194

Subnet Mask: 255 . 255 . 248 . 0

Gateway: 19 . 19 . 0 . 1

MTU: 1500

Obtain an IPv6 address automatically

Address: [Empty]

Mask Length: [Empty]

Gateway: [Empty]

Obtain DNS automatically

Preferred DNS: [Empty]

Alternate DNS: [Empty]

Advanced

Apply

### 11.1.2 Port Configuration

Click Start→Settings→Network→Port to go to the interface as shown below. Enter the HTTP port, HTTPS Port, server port, RTSP and POS port of the DVR, enable “Anonymous” as required and then click “Apply” to save the settings.

Port

HTTP Port: 80

HTTPS Port: 443

Server Port: 6036

RTSP Port: 554  Anonymous

POS Port: 9036

Apply

**HTTP Port:** the default HTTP port of the DVR is 80. The port number can be changed to others like 81. The port is mainly used to client remote access. If you want to access the DVR through a web browser, you should enter IP address plus HTTP port in the address bar like `http://192.168.11.61:81`.

**HTTPS Port:** the default HTTPS port of the DVR is 443.

HTTPS provides authentication of the web site and protects user privacy. How to use it?

① Enter IP address plus HTTP port in the address bar of the web browser. Then enter username and password to log in. Click Functional Panel→Network→HTTPS to go to the following interface.

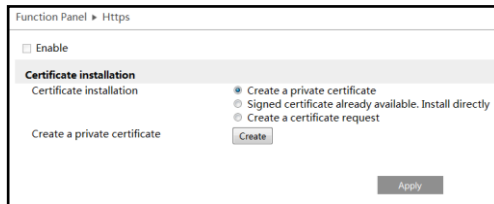

② Install a certificate.

\* You can create a private certificate here. Click the “Create” button to create a private certificate. Enter the country (only two letters available), domain (NVR’s IP address/domain), validity date, password, province/state, region and so on. Then click “OK” to save the settings.

\* If there is a signed certificate, click “Browse” to select it and then click “Install” to install it.

\* Click “Create a certificate request” to enter the following interface.

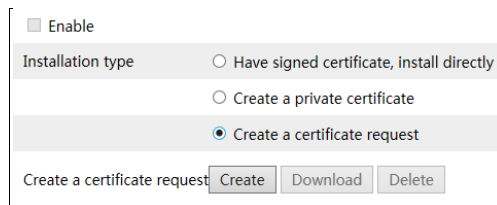

Click “Create” to create the certificate request. Then download the certificate request and submit it to the trusted certificate authority for signature. After receiving the signed certificate, import the certificate to the device.



③ After the certificate has been installed, enable this function and apply it. Then the camera can be accessed by entering `https://IP: https port` via the web browser (eg. `https://192.168.1.201:443`).

**Server Port:** the default server port of the DVR is 6036. The server port number can be changed as required. The port is mainly used in network video management system.

**RTSP Port:** RTSP real-time stream protocol can be used to control the sending of real-time data. By media player which supports the RTSP real-time stream protocol, you can view the live images synchronously. The default RTSP port is 554 and it can be changed as needed.

**POS Port:** the default POS port of the DVR is 9036.

*Note: The HTTP port and server port of the DVR should be mapped to the router before you access the DVR via WAN.*

### 11.1.3 PPPoE Configuration

Click Start→Settings→Network→PPPoE to go to the interface as shown below. Check “Enable” in “PPPoE Settings” and then enter the username and password obtained from the dealer. Click “Apply” to save the settings.

### 11.1.4 DDNS Configuration

The DDNS is used to control the dynamic IP address through domain name. You can access the DVR easily if the DDNS is enabled and configured.

Click Start→Settings→Network→DDNS to go to the interface as shown below.

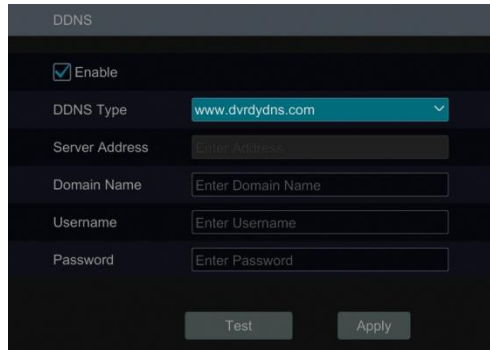

DDNS

Enable

DDNS Type: www.dvrdydns.com

Server Address:

Domain Name:

Username:

Password:

Test Apply

Check “Enable” and then select the DDNS type. Enter the server address, domain name, username and password according to the selected DDNS type. Click “Test” to test the effectiveness of the input information. Click “Apply” to save the settings.

You will have to enter the server address and domain name if some DDNS types are selected. Go to the relative DNS website to register domain name and then enter the registered domain information here). Now we take **www.dvrdydns.com** for example.

① Enter **www.dvrdydns.com** in the address bar of a web browser to visit its DNS website.



Welcome to DvrDydns

Enter your user name and password. Choose logon to continue.

Enter your user name and password below.

USER LOGON

USER NAME:

PASSWORD:

Password is case sensitive.

Logon Reset

Forgot your password?

② Click **Registration** to go to the interface as shown below. Set the DDNS account information (username, password and so on) and then click **Submit** to save the account.

*DDNS account creation.*

NEW USER REGISTRATION	
USER NAME	<input type="text"/>
PASSWORD	<input type="password"/> ?
PASSWORD CONFIRM	<input type="password"/>
FIRST NAME	<input type="text"/>
LAST NAME	<input type="text"/>
SECURITY QUESTION.	My first phone number. ▾
ANSWER	<input type="text"/>
CONFIRM YOU'RE HUMAN	<p style="text-align: center;">7+1= New Captcha</p> <input type="text"/> <p>Solve the problem above.</p>
<input type="button" value="Submit"/> <input type="button" value="Reset"/>	

Already have an account? [Click here to logon.](#)

- ③ Create domain name and then click **Request Domain**.

## Domain Name Creation

Enter a new domain name below.

---

*You must create a domain name to continue.*

Domain name must start with (a-z, 0-9), must be least 3 char!. Cannot end or start, but may contain a hyphen and is not case-sensitive.

.  ▾

- ④ After you successfully request your domain name, you will see your domain name information in the list.

## My Domains

Your domain names are listed below. Choose create new domain to add additional domain names.

Your domain was successfully created.

Click a name to edit your domain settings.

NAME	STATUS	DOMAIN
REDSUNSHINE	✔	redsunsunshine.dvrddns.com
Last Update: <span style="color: red;">Not yet updated</span> IP Address: 210.21.229.138		

Create additional domain names

[1]

- ⑤ Click Start→Settings→Network→DDNS to go to DDNS setting interface. Enable DDNS and then select the **www.dvrddns.com** DDNS type. Enter the registered username, password and domain name and then click “Apply”.
- ⑥ Map the IP address and HTTP port in the router (you can skip this step if UPnP function is enabled).
- ⑦ Enter the registered domain name plus HTTP port like **http://www.xxx.dvrddns.com:81** in the address bar and then press Enter key to go to the client.

### 11.1.5 E-mail Configuration

Click Start→Settings→Network→E-mail to go to the following interface.

Sender

Sender Name

Email Address

SMTP Server

SMTP Port

Security

Attaching Image

Anonymous Login

Username

Password

Enter the sender’s name, e-mail address, SMTP server and SMTP port (you can click “Default” to reset the SMTP port to the default value) and then enable or disable the SSL and attaching image. Select the username (the username list will be updated automatically according to the

email address you enter) and enter the password of the sender and then click “Apply” to save the settings (you don’t have to enter the username and password if “Anonymous Login” is enabled). Click “Test” to pop up a window. Enter the e-mail address of the recipient in the window and then click the “OK” button. The e-mail address of the sender will send an e-mail to the recipient. If the e-mail is sent successfully, it indicates that the e-mail address of the sender is configured correctly.

Click “Edit Recipient” to go to the following interface.

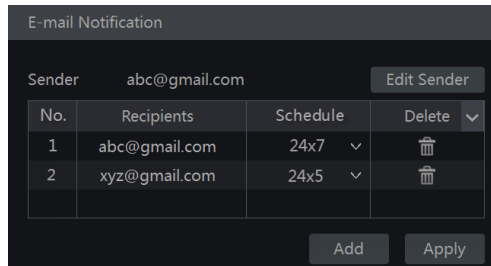

Click “Add” and then enter the recipient’s e-mail address and select the schedule (if a schedule is selected, the system will send the alarm email and the recipient will receive it only in the selected schedule time) in the popup window. Click “Add” in the window to add the recipient. You can also change the recipient’s receiving schedule by clicking in the “Schedule” column. Click to delete the recipient in the list. Click “Apply” to save the settings. Click “Edit Sender” to go to the e-mail configuration interface of the sender.

### 11.1.6 UPnP Configuration

By UPnP you can access the DVR through the web client which is in WAN via router without port mapping.

- ① Click Start→Settings→Network→UPnP to go to the following interface.
- ② Make sure the router supports UPnP function and the UPnP is enabled in the router.
- ③ Set the DVR’s IP address, subnet mask and gateway and so on corresponding to the router.
- ④ Check “Enable” in the interface as shown below and then click “Apply”.

Click “Refresh” to refresh the UPnP status. If the UPnP status were still “Invalid UPnP” after refreshing it for many times, the port number would be wrong. Please change the mapping type to “Manual” and then click to modify the port until the UPnP status turns to “Valid UPnP”. Refer to the following picture. You can view the external IP address of the DVR. Enter the external IP address plus port in the address bar to access the DVR such as http://183.17.254.19:81.

UPnP

Enable

Map Type: Manual

Port Type	External Port	External IP Address	Port	UPnP Status	Edit
HTTP Port	80	183.17.254.19		Valid UPnP	
HTTPS Port	443	183.17.254.19		Valid UPnP	
Server Port	6036	183.17.254.19		Valid UPnP	
RTSP Port	554	183.17.254.19		Valid UPnP	

Refresh Apply

### 11.1.7 NAT Configuration

Click Start→Settings→Network→NAT to go to the interface for NAT configuration. Check “Enable” and then select the NAT server address. Click “Apply” to save the settings.

You can scan the QR Code through mobile APP on your mobile phone or tablet to log into the recorder instantly.

### 11.1.8 802.1X

If it is enabled, the NVR data can be protected. When the NVR is connected to the network protected by the IEEE 802.1X, user authentication is needed.

802.1x

Enable

Protocol: EAP\_MD5

Eapol Version: 1

Username: Enter Username

Password: Enter Password

Apply

To use this function, the NVR shall be connected to a switch supporting 802.1x protocol. The switch can be considered as an authentication system to identify the device in a local network. If the NVR connected to the network interface of the switch has passed the authentication of the switch, it can be accessed via the local network.

Protocol type and EAPOL version: Please use the default settings.

User name and password: The user name and password must be the same with the user name and password applied for and registered in the authentication server.

### 11.1.9 FTP Configuration

Some models may not support this function.

Click Start→Settings→Network→FTP to go to the interface for FTP configuration. Check “Enable” and enter the server name, port, username and password, max file size and remote directory.

### 11.1.10 Platform Access

Some models may not support this function.

This function is mainly used for connecting ECMS/NVMS. The setting steps are as follows.

Click Start→Settings→Network→Platform Access to go to the interface.

#### Platform Access

- ① Set “Access Type” as “Platform Software” and select “Enable” as shown below.
- ② Check the IP address and port of the transfer media server in the ECMS/NVMS. The default server port for auto report is 2009. If it is modified, please go to the transfer media interface to check.
- ③ Enable the auto report in the ECMS when adding a new device. Then self-define device ID and fill out the remaining information of the device in the ECMS/NVMS.
- ④ Enter the above-mentioned server address, port and report ID in the server interface. Then click the “Apply” button to save the settings. Now the ECMS/NVMS system will automatically connect this device.

Platform Access

Access Type Platform Software

Enable

Server Address 192.168.1.200

Port 2009

Report ID 1

Report Status Failure

Apply

### 11.1.11 3G/4G (Optional)

- ① Plug in the USB wireless device with SIM card.
- ② Click Start→Settings→Network→3G/4G to go to the interface for wireless settings.

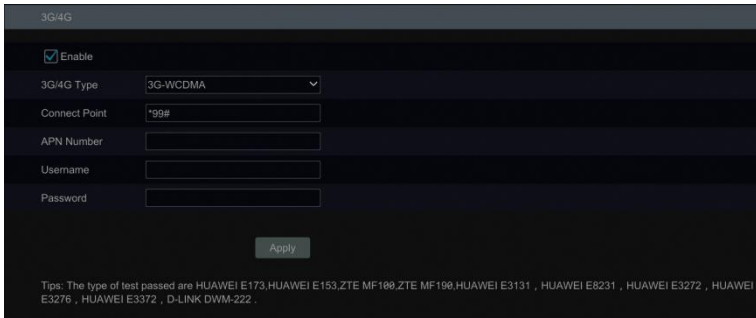

- ③ Enable 3G/4G function.
- ④ Choose the 3G/4G type as needed.
- ⑤ Click “Network Status” to view the 3G/4G connection status and get the IP address.

### 11.1.12 Wi-Fi (Optional)

- ① Plug in the USB Wi-Fi search device.
- ② Click Start→Settings→Network→ Wi-Fi to go to the interface for wireless settings.
- ③ Enable Wi-Fi function. Click “Refresh” and then the system will automatically search wireless routers.



- ④ Choose the desired wireless router and then click “Connect”.



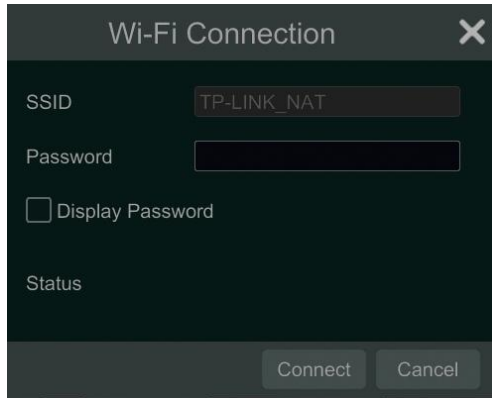

- ⑤ Enter the key/password in the Wi-Fi connection box and then click “Connect”. The connection status will be displayed after the Wi-Fi is connected.
- ⑦ Exit the Wi-Fi connection interface, you can view the detailed Wi-Fi information, such as IP address, gateway, etc.

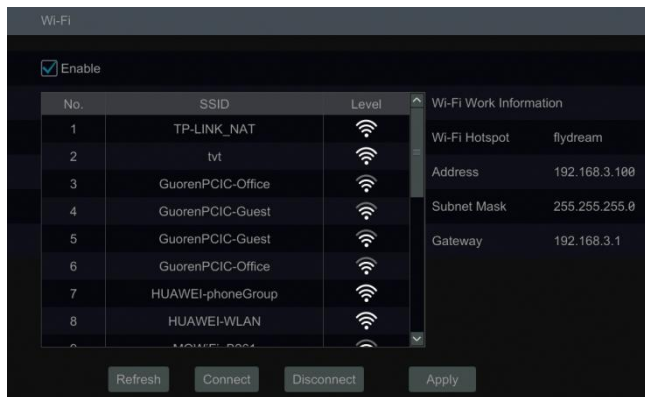

### 11.1.13 SNMP (Optional)

- ① Click Start→Settings→Network→SNMP to go to the interface for SNMP configuration.

SNMP

Enable SNMPv1

Enable SNMPv2

SNMP Port

Read Community

Write Community

Trap Address

Trap Port

Apply

- ② Check SNMPv1 or SNMPv2 to enable this function.
- ③ Set the port of the SNMP.
- ④ Set the trap address and the trap port.
- ⑤ Click “Apply” to save the settings.

Trap Address: The IP address of SNMP host.

Trap Port: The port of SNMP host.

**Tips:** Before setting the SNMP, please download the SNMP software and manage to receive the device information via SNMP port. By setting the trap address, the device is allowed to send the alarm event and exception message to the monitoring center.

### 11.1.14 View Network Status

Click Start→Settings→Network→Network Status to view the network status or click  on the tool bar at the bottom of the live view interface to view network status conveniently.

## 11.2 Basic Configuration

### 11.2.1 Common Configuration

Click Start→Settings→System→Basic→General Settings to go to the following interface.

Set the device name, device No., language, video format and main output resolution. Enable or disable wizard, “Log In Automatically”, “Log Out Automatically” (if checked, you can set the wait time) “App Live Self-Adaption” and “Dwell Automatically” (if checked, you can set the wait time). Click “Apply” to save the settings.

**Device Name:** The name of the device. It may display on the client end or CMS that help user to recognize the device remotely.

**Video Format:** Two modes: PAL and NTSC. Select the video format according to the camera.

**Spot:** If the DVR supports spot output, you can enable spot output. Connect the spot output device to the DVR and then set the spot output (see [5.2.4 Spot View](#) for details).

**Dwell Automatically:** Switch automatically. Check it and set “wait time”.The system will switch images automatically if it is not operated during the time you set.

## 11.2.2 Date and Time Configuration

Click Start→Settings→System→Basic→Date and Time to go to the interface as shown below. Set the system time, date format, time format and time zone of the DVR. The default time zone is GMT+08 Beijing, Hong Kong, Shanghai, Taipei. If the selected time zone includes DST, the DST of the time zone will be checked by default. Click “Apply” to save the settings.

You can manually set the system time or synchronize system time with network through NTP.

**Manual:** select “Manual” in the “Synchronous” option and then click  after the “System Time” option to set the system time.

**NTP:** select “NTP” in the “Synchronous” option and then choose the NTP server.

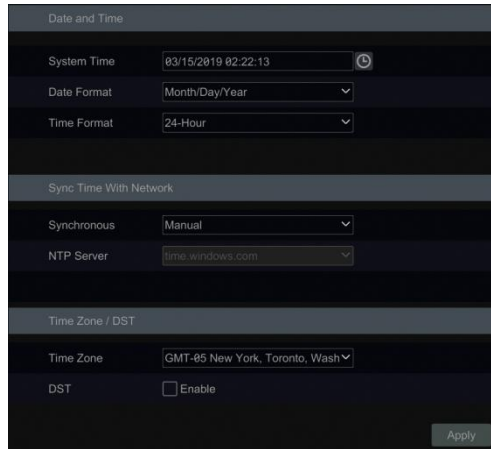

### 11.2.3 Recorder OSD Settings

Click Start→Settings→System→Basic→Recorder OSD settings to go to the following interface. OSD name and icon can be enabled here.

## 11.3 Factory Default

Click Start→Settings→System→Maintenance→Factory Default and then click the “Reset to factory default” button in the interface to reset to the factory default settings(check “Reset retain Network Configuration” to retain the network settings).

**Note:** Resetting to the factory default settings will not change time zone.

## 11.4 Device Software Upgrade

### ● Common Upgrade

You can click Start→Settings→System→Information→Basic to view MCU, kernel version and firmware version and so on. Before upgrade, please get the upgrade file from your dealer.

The upgrade steps are as follows:

- ① Copy the upgrade software (.tar) into the USB storage device.
- ② Insert the USB storage device into the USB interface of the DVR.
- ③ Click Start→Settings→System→Maintenance→Upgrade to go to “Upgrade” interface. Select the USB device in “Device Name” option and go to the path where the upgrade software exists. Select the upgrade software and then click “Upgrade”. The system may automatically restart during upgrading. Please wait for a while and do not power off the DVR during upgrading.

**Note:** The file system of the USB mobile device which is used for upgrading, backing up and restoring should be FAT32 format.

- **Flash Upgrade**

The upgrade steps are as follows:

- ① Copy the flash upgrade files into the USB storage device.
- ② Insert the USB storage device into the USB interface of the DVR.
- ③ Restart the DVR. Then the system will automatically upgrade.

- **Cloud Upgrade**

- ① Click Start→Settings→System→Maintenance→Cloud Upgrade to go to “Cloud Upgrade” interface.
- ② Enable “Auto-check for updates” to check if the current version is the latest one automatically. You can also click “Check for updates” to check the version by yourself. If it is not the latest one, obtain the latest version from the cloud server and then click “Upgrade”. The system may automatically restart during upgrading. Please wait for a while and do not power off the device during upgrading.

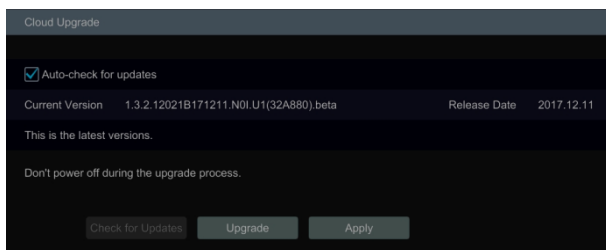

## 11.5 Backup and Restore

You can back up the configuration file of the DVR by exporting the file to other storage devices; you can recover the configuration to other DVRs which are of the same model with the DVR by importing the configuration file to other DVRs for time saving.

Insert the USB storage device into the USB interface of the DVR and then click Start→Settings→System→Maintenance→Backup and Restore to go to the interface.

- **Backup**

Select the USB device in “Device Name” option; go to the path where you want to store the configuration backup file and then click the “Backup” button; finally click the “OK” button in the popup window.

- **Recover**

Select the USB device in “Device Name” option; find the configuration backup file and then click the “Recover” button; finally click the “OK” button in the popup window.

## 11.6 Restart Automatically





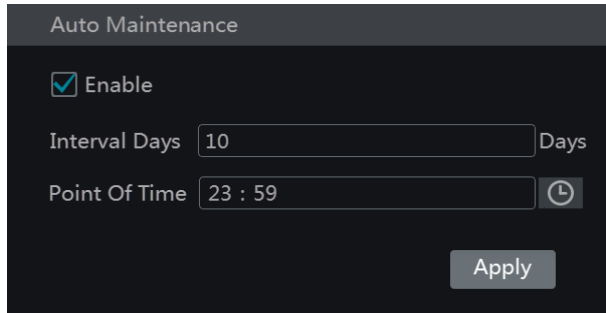









You can set the automatic restart time for the DVR to maintain it regularly. Click

Start→Settings→System→Maintenance→Auto Maintenance to go to the interface as shown below. Enable auto maintenance, set the interval days and point of time and then click “Apply” to save the settings. The DVR will restart automatically at the pointed time every interval days.





## 11.7 View Log

Click Start→Settings→System→Maintenance→View Log to go to the log view interface. Select the log main type, click  to set start time and end time and then click the “Search” button. The searched log files will be displayed in the list.

No.	Main Type	Log Time	Content	Details	Play
1	Alarm	11/03/2015 15:58:53	Motion Alarm		
2	Settings	11/03/2015 15:43:01	Local Basic		—
3	Operation	11/03/2015 15:34:53	Local Search/Playback/Backup		—
4	Alarm	11/03/2015 15:25:43	Motion Alarm		
5	Settings	11/03/2015 15:25:38	Local Camera Parameters		—
6	Operation	11/03/2015 15:20:15	Local Search/Playback/Backup		—
7	Settings	11/03/2015 15:05:38	Local Camera Parameters		—
8	Settings	11/03/2015 15:05:06	Local Record Parameters		—
9	Exception	11/03/2015 15:04:48	IPC Offline		—
10	Settings	11/03/2015 15:04:46	Local Camera Parameters		—
11	Operation	11/03/2015 15:03:49	Local Login / Logout		—
12	Operation	11/03/2015 15:03:12	Local Maintenance		—

Current Page: 1 / 1, All 12 

Choose the log file in the list and then click the “Export” button to export the log file. Click  on the “Content” title bar to pop up a menu list. Check contents in the menu list and then the log list will show the checked log contents only. Click  to play the video log.

## 11.8 View System Information

Click Start→Settings→System→Information and then click the corresponding menu to view

the “Basic”, “Camera Status”, “Alarm Status”, “Record Status”, “Network Status” and “Disk” information of the system.

# 12 Remote Surveillance

## 12.1 Mobile Client Surveillance

- ① Enable NAT in the DVR. Refer to [11.1.7 NAT Configuration](#) for details.
- ② Download and install the mobile client “SuperLive Plus” into the mobile device with the Android or iOS system.
- ③ Run the mobile client, go to the “Add Device” interface and then click  to scan the QRCode of the DVR (Go to Start→Settings→System→Information→Basic to view the QRCode of the DVR).
- ④ After scanning the QRCode successfully, enter the login password to log in mobile client.

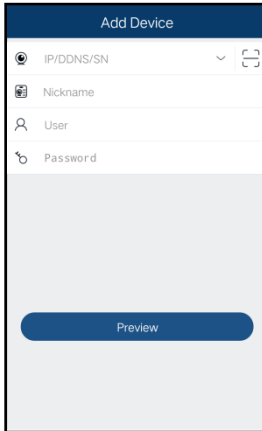

## 12.2 Web LAN Access

- ① Click Start→Settings→Network→TCP/IP to go to the “TCP/IP” interface. Set the IP address, subnet mask, gateway, preferred DNS and alternate DNS of the DVR.
- ② Open a web browser on your computer, enter the IP address of the DVR in the address bar and then press enter to go to the login interface as shown below. You can change the display language on the top right corner of the login interface. Enter the username and password of the DVR in the interface and then click “Login” to go to the live view interface.



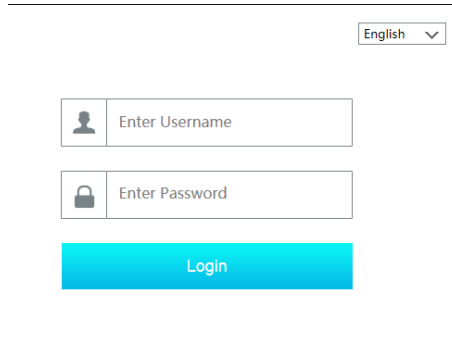

The login interface features a language dropdown menu in the top right corner set to 'English'. Below it are three input fields: the first contains a user icon and the text 'Enter Username'; the second contains a lock icon and the text 'Enter Password'. A prominent blue 'Login' button is positioned below these fields.

*Notes:*

1. Please make sure that the IP address of the DVR and the computer are both in the same local network segment. For example, supposing that the IP address of the computer is 192.168.1.41, the IP address of the DVR shall be set to 192.168.1.XXX.
2. If the HTTP port of the DVR is not 80, but other number instead, you need to enter the IP address plus port number in the address bar of the web browser when accessing the DVR over network. For example, the HTTP port is 81. You should enter `http://192.168.1.42:81` in the address bar of the web browser.

## 12.3 Web WAN Access

### ➤ NAT Access

- ① Set the network of the DVR. Please refer to [11.1.1 TCP/IP Configuration](#) for details.
- ② Enable NAT and then set the NAT server address. Please refer to [11.1.7 NAT Configuration](#) for details.
- ③ Open a web browser on your computer, enter the NAT server address **www.autonat.com** in the address bar and then press enter to go to the interface as shown below (download and install the relative plugin according to the popup tip if you access the DVR through NAT for the first time).

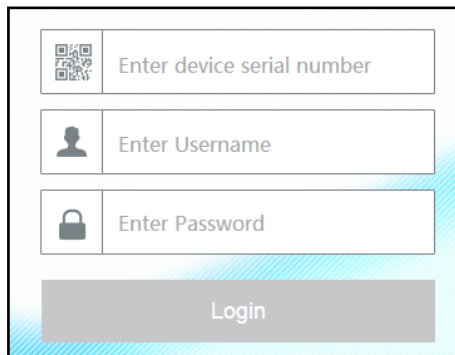

The NAT access login interface includes a QR code icon and the text 'Enter device serial number' in the top input field. Below it are two more input fields: one with a user icon and 'Enter Username', and another with a lock icon and 'Enter Password'. A grey 'Login' button is located at the bottom of the form.

Enter the serial number (click  on the tool bar at the bottom of the live view interface to see the serial number of the DVR), user name (the user name of the DVR, **admin** by default) and password (the password of the DVR, **123456** by default) of the DVR, select the display language on the top right corner of the interface and then click the “Login” button to go to the web client interface.

#### ➤ PPPoE Access

- ① Click Start→Settings→Network→PPPoE to go to the “PPPoE” interface. Check “Enable” in the “PPPoE settings” and then enter the username and password you get from your ISP. Click “Apply” to save the settings.
- ② Click Start→Settings→Network→Network Status to view the IP address of the DVR.
- ③ Open a web browser on your computer, enter the IP address of the DVR like <http://210.21.229.138> in the address bar and then press enter to go to the login interface. Enter the username and password of the DVR in the interface and then click “Login” to go to the live view interface.

#### ➤ Router Access

- ① Click Start→Settings→Network→TCP/IP to go to the “TCP/IP” interface. Set the IP address, subnet mask, gateway, preferred DNS and alternate DNS of the DVR.
- ② Set the HTTP port (it is suggested to modify the HTTP port because the default HTTP port 80 might be taken up) and enable UPnP function in both the DVR and the router. If the UPnP function is not available in the router, you need to forward the LAN IP address, HTTP port and server port of the DVR to the router. Port mapping settings may be different in different routers, so please refer to the user manual of the router for details.
- ③ Get the WAN IP address of the DVR from the router. Open a web browser on your computer, enter the WAN IP address plus HTTP port like <http://116.30.18.215:100> in the address bar and then press enter to go to the login interface. Enter the username and password of the DVR in the interface and then click “Login” to go to the live view interface.

*Note: If the WAN IP address is a dynamic IP address, it is necessary for you to use the domain name to access the DVR. Click Start→Settings→Network→DDNS to set DDNS (see [11.1.4 DDNS Configuration](#) for details). By using DDNS function you can use the domain name plus HTTP port like <http://sunshine.dvrddns.com:100> to access the DVR via internet.*

## 12.4 Web Remote Control

The supported browsers for remote access are IE8/9/10/11, Firefox, Opera and Chrome (available only for the versions lower than 45) in Windows system and Safari in MAC system. When you access the DVR through IE for the first time, you need to download and install the relative components for normal preview and playback. Please refer to the tips in the remote interfaces for details. The buttons and icons on the top right corner of the remote interface are introduced as follows.

**admin:** the current login username.

**Logout:** click it to log out and return to the login interface.

**Modify Password:** click it to change the password of the current login user. Enter the current password and then set a new password in the popup window. Click the “OK” button to save the new password.

**Local Settings:** click it to change the local settings. Set the snapshot number and click “Browse” to set the snapshot path and record path as shown below. Click the “Apply” button to save the settings.

Snapshots number	5	▼
Save snapshots to	C:\Users\Administrator\Pictures	Browse
Save record files to	C:\Users\Administrator\Videos	Browse
Apply		

### 12.4.1 Remote Preview

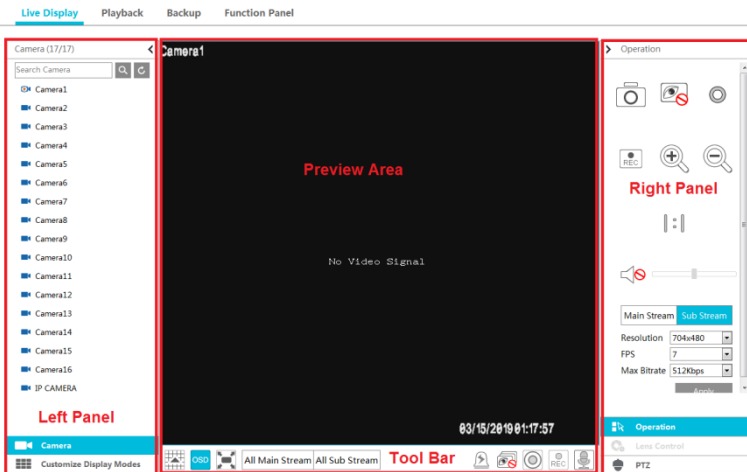

Click “Live Display” in the remote interface to go to the preview interface. The preview interface consists of the four areas marked in the following picture.





#### ➤ Start Preview











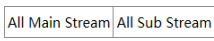

Select a window in the preview area and then click one online camera on the left panel to preview the camera in the window. You can click  in the tool bar to preview all the cameras.

#### ➤ Left Panel Introduction





Click  on the left panel to hide the panel and click  to show the panel. You can view all the added cameras and groups on the left panel.

You can view the number of all the added cameras and the online cameras. For instance, the left number 3 in **Camera (3/4)** on the left panel stands for the number of online cameras; the right number 4 stands for the number of all the added cameras. Enter the camera name in the search box and then click  to search the camera. Click  to refresh the camera list.

### ➤ Tool Bar Introduction

Button	Meaning
	Screen mode button.
	Click it to disable OSD. Click  to enable OSD.
	Click it to show full screen. Right click on the full screen to exit full screen.
	Click “All Main Stream” or “All Sub Stream” to set the stream of all the cameras.
	Manual alarm button. Click it to pop up a window and then trigger and clear the alarm-out in the window manually.
	Click it to preview all the cameras.
	Click it to close all the preview cameras.
	Click it to start recording for all cameras to computer. Click  to stop recording.
	Click it to start recording for all cameras to the DVR. Click  to stop recording.
	Click it to enable talk with the DVR.

### ➤ Right Panel Introduction

Click  on the right panel to show the panel and click  to hide the panel. Click  **PTZ** at the bottom of the panel to go to “PTZ” panel. Click  **Operation** to go to “Operation” panel.

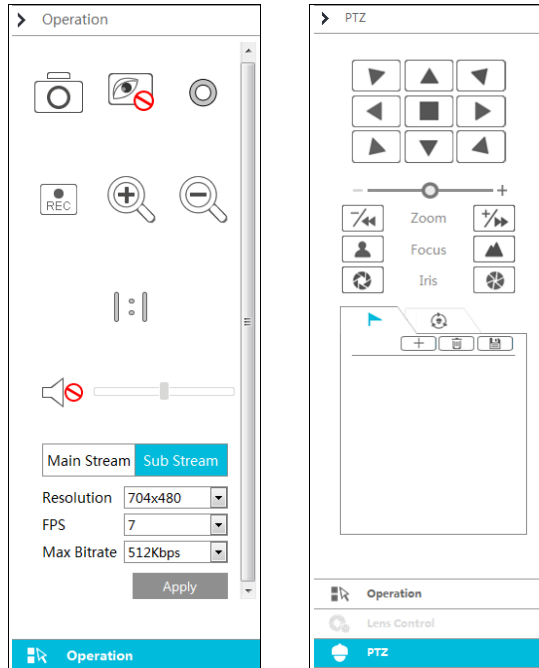









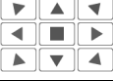







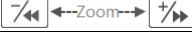

Click one camera window in the preview area and then click **Main Stream** to set the camera's live preview stream and record stream to main stream in manual record mode; click **Sub-stream** to set the camera's live preview stream and record stream to sub stream. In sub stream tab, set the resolution, FPS and bitrate and then click "Apply" to save the settings.

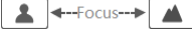
**Operation** panel introduction:

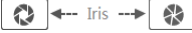
Button	Meaning
	Click it to snap.
	Click it to start record to computer
	Click it to start record to the NVR.
	Click it to zoom in the image of the camera and then drag the mouse on the camera image to view the hidden area.
	Click it to zoom out the image of the camera.
	The 3D zoom in function is designed for P.T.Z. Click the button and then drag the image to zoom in or zoom out the image; click the image on different areas to view the image of the dome omni-directionally.
	Click it to close the preview camera.
	Click it to enable audio and then drag the slider bar to adjust the volume. You can listen to the camera audio by enabling audio.



**PTZ** panel introduction:

Button	Meaning
	Click  /  /  /  /  /  /  /  to rotate the dome; click  to stop rotating the dome.
	Drag the slider to adjust the rotating speed of dome.
	Click  /  to zoom in/out camera image.
	Click  /  to increase/ decrease the focal length.
	Click  /  to increase/decrease the iris of the dome.
	Click it to view the preset list and then click the button in the list to call the preset.
	Click it to view the cruise list and then click the corresponding buttons in the list to start or stop the cruise.

## 12.4.2 Remote Playback



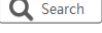











Click “Playback” in the remote interface to go to the playback interface.





① Check the record event types and cameras on the left panel. Set the record date on the calendar beside the time scale.

② Click  to search the record data and then click  or directly click the time scale to play the record.

The operation of the playback time scale is similar to that of the time scale in the main program of the DVR. Please refer to [8.2 Playback Interface Introduction](#) for details.

**Introduction of playback control buttons:**



Button	Meaning
	Stop button.
	Rewind button. Click it to play video backward.
	Play button. Click it to play video forward.
	Pause button.
	Deceleration button. Click it to decrease the playing speed.
	Acceleration button. Click it to increase the playing speed.
	Previous frame button. It works only when the forward playing is paused in single screen mode.
	Next frame button. It works only when the forward playing is paused in single screen mode.
	Click  to step backward 30s and click  to step forward 30s.
	Click it to show the water mark on the image; click  to hide the water mark
POS	Click to view POS
	Backup start time button. Click the time scale and then click it to set the backup start time.

Button	Meaning
	Backup end time button. Click the time scale and then click it to set the backup end time.
	Backup button.
	Backup tasks button. Click it to view the backup status.
	Event list button. Click it to view the event record of manual/schedule/sensor/motion.



### 12.4.3 Remote Backup

Click “Backup” in the remote interface to go to the backup interface. You can back up the record by event or by time.

#### ➤ By Event

Check the record type on the left side of the interface and then click  to set the start time and end time; check the cameras and then click  on the right side to search the record (the searched record data will be displayed in the list); check the record data in the list and then click the “Backup” button to backup the record.

#### ➤ By Time

Click  to set the start time and end time on the left side of the interface; check the cameras and then click  on the right side to backup the record.

**View Backup Status:** Click “Backup Status” to view the backup status. Click “Pause” to pause the backup; click “Resume” to continue the backup; click “Delete” to delete the task.

### 12.4.4 Remote Configuration

Click “Function Panel” in the remote interface and then configure the camera, record, alarm, disk, network, account and authority and system of the DVR remotely. All of these settings are similar to that of the DVR. See the configurations of the DVR for details.

## Appendix A FAQ

### Q1. Why can't I find the HDD?

- a. Please check the power and SATA data cables of the HDD to make sure they are well connected.
- b. For some DVRs with the 1U or small 1U case, the power of the adapter may be not enough for operating them. Please use the power adaptor supplied along with the DVR.
- c. Please make sure the HDDs are compatible with the DVR. See [Appendix C Compatible Device List](#) for details.
- d. The HDD could have gone bad.

### Q2. Why are there no images output in some or all of the camera windows?

- a. Please make sure the resolutions of the cameras are supported by the DVR.
- b. Please make sure the network cables of the IP camera and DVR are both connected properly and the network parameters are set correctly.
- c. Please make sure the analog camera is connected properly.
- d. Please make sure the network and the switch both work normally.

### Q3. The screen has no output after booting the DVR normally.

- a. Please make sure the screen, HDMI or VGA cables are good and well connected.
- b. Please make sure the screen supports the resolution of 1280\*1024, 1920\*1080, 2560\*1440 or 3840\*2160(4K\*2K). The DVR cannot self-adapt to the screen of which the resolution is lower than 1280\*1024, and then the screen will remind you that the screen resolution is not supported by the DVR or just have no display. Please change a screen at 1280\*1024, 1920\*1080, 2560\*1440 or 3840\*2160 resolution before booting the DVR.

### Q4. Forget the passwords?

- a. The password for *admin* can be reset through “Edit Security Question” function. Click the “Edit Security Question” button in the login window and then enter the corresponding answer of the selected question in the popup window, the password for *admin* will be reset to **123456** by default. If you forget the answer of the question, this way will be invalid, please contact your dealer for help.
- b. The passwords of other users can be reset by *admin*, please refer to [10.1.2 Edit User](#) for details.

### Q5. The DVR cannot add up to the maximum number of IP cameras?

Take the 4 CH DVR as an example. Refer to the picture below. The remaining bandwidth should be larger than the bandwidth of the IP camera you want to add, or you would fail to add the IP camera. You should lower the added cameras' bitrate to release the bandwidth. It is recommended to add cameras by “Quickly Add” for batch adding.



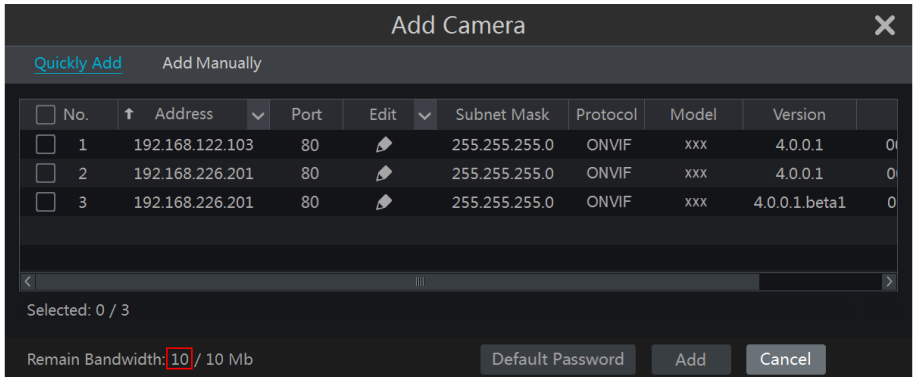

### Q6. The system cannot record, why?

- Make sure the HDD was formatted prior to use.
- The record schedule has not been set in manual record mode. Please refer to [7.3.2 Record Schedule Configuration](#) for details.
- Maybe HDD is full and thus the DVR is not able to record. Check HDD information from Disk Management and if required, please enable the recycle function (please see [7.1.2 Advanced Configuration](#) for details).
- There is no disk but cameras in the disk group, so please add at least one disk to the group. Refer to [7.5.1 Storage Mode Configuration](#) for details.
- The HDD could have gone bad. Please change another one.

### Q7. Fail to access the DVR remotely through IE.

- Please make sure the IE version is IE8 or above.
- Please check whether the PC has enabled the firewall or installed the antivirus software. Please try to access the DVR again after you disable the firewall and stop the antivirus software.
- Black & white list may have been set in Account and Authority setting. The PC of which the IP address is in the black list or out of the white list cannot access the DVR remotely.

### Q8. ActiveX control cannot be downloaded. What can I do?

- IE browser blocks ActiveX control. Please do setup as per the steps mentioned below.
  - Open IE browser. Click → Internet Options.

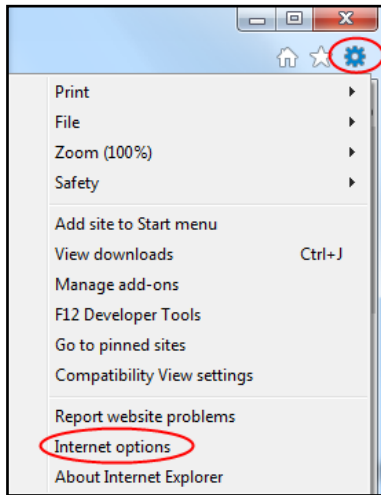

- ② Select Security→Custom Level. Refer to Fig 8-1.
  - ③ Enable all the sub options under “ActiveX controls and plug-ins”. Refer to Fig 8-2.
  - ④ Then click “OK” to finish setup.
- b. Other plug-ins or anti-virus may block ActiveX. Please disable or do the required settings.

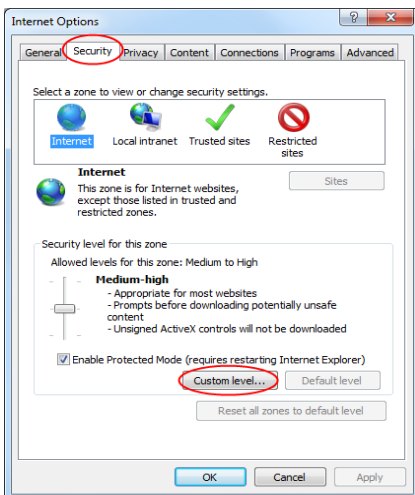

Fig 8-1

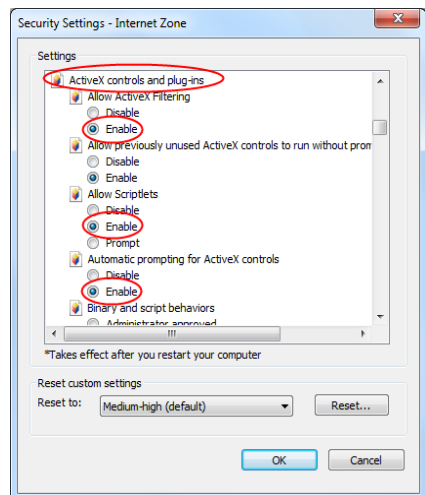



Fig 8-2

## Q9. How to play the backup file?

- a. Record backed up by DVR: insert the USB device in which the record backup files is saved to the USB interface of the PC and then open the USB device path. The record can be backed up in the private format and AVI format by DVR.

- If you select the private format when backing up recorded video by DVR, a RPAS compression package will be backed up to the USB device automatically along with the record data. Uncompress the “RPAS.zip” and then click “RPAS.exe” to set up RPAS. After the setup is completed, open RPAS player and then click the “Open Folder” button in the middle of the interface to select the record data. Refer to Fig 9-1.

Select camera in the resource tree on the left side of the interface to play the camera record. Click  on the tool bar under the camera image to enable audio. Refer to Fig 9-2.

*Note: The record will not have audio output if you disable the audio when recording by DVR. Please see [7.1.1 Mode Configuration](#) and [7.2 Encode Parameters Setting](#) for details.*

- If you select the AVI format when backing up recorded video by DVR, the recorded video backup data can be played by the video player which supports this format.
  - b. Recorded video backed up through web. The recorded video can only be backed up with AVI format through web. The recorded video can be backed up to PC and played by the video player which supports this format.

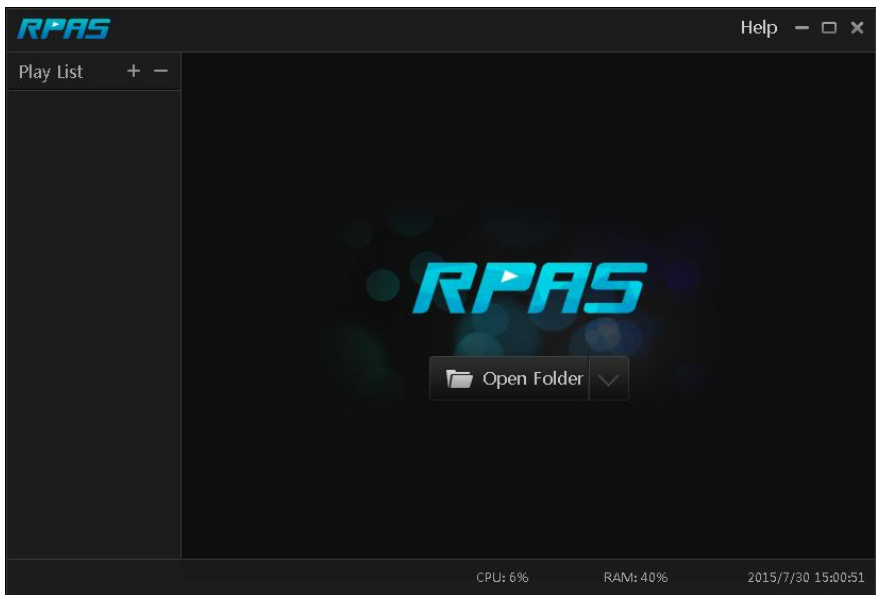

Fig 9-1

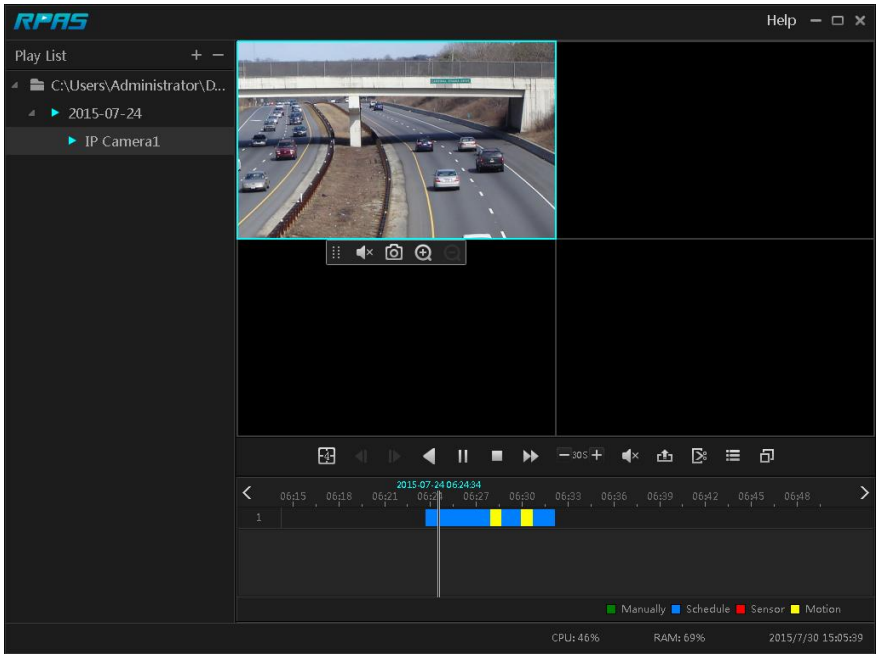

Fig 9-2

## Appendix B Calculate Recording Capacity

The recording capacity is mainly up to the record resolution, record stream and bitrate. Different image quality parameters decide different disk capacity occupation in equal times. The bigger the record resolution, record stream and record bitrate is, the more disk capacity is taken up in equal times. The calculation format of recording capacity is shown as below.

$$\text{Recording Capacity(MB)} = \text{Bitrate(Kbps)} \div 1024 \div 8 \times 3600 \times \text{Recording hours per day} \times \text{Record Storage Days} \times \text{channel numbers}$$

3600 means record for an hour(1TB=1024GB , 1GB=1024MB , 1MB=1024KB , 1Byte=8bit).

Record Bitrate (Kbps)	Used Space (MB/H)	Used Space (MB/D)
10240	4500	108000
8192	3600	86400
6144	2700	64800
4096	1800	43200
3072	1350	32400
2048	900	21600
1024	450	10800
768	337.5	8100
512	225	5400
384	168.75	4050
256	112.5	2700

The table below shows the recording capacity requirements for record storage in 30 days.

Record Bitrate (Kbps)	Recording Capacity(TB)					
	1CH	4CH	8CH	16CH	32CH	64CH
10240	3.09	12.36	24.72	49.44	98.88	197.76
8192	2.48	9.89	19.78	39.56	79.11	158.21
6144	1.86	7.42	14.84	29.67	59.33	118.66
4096	1.24	4.95	9.89	19.78	39.56	79.11
3072	0.93	3.71	7.42	14.84	29.67	59.33
2048	0.62	2.48	4.95	9.89	19.78	39.56
1024	0.31	1.24	2.48	4.95	9.89	19.78
768	0.24	0.93	1.86	3.71	7.42	14.84
512	0.16	0.62	1.24	2.48	4.95	9.89
384	0.12	0.47	0.93	1.86	3.71	7.42
256	0.08	0.31	0.62	1.24	2.48	4.95

For instance, there is a 32CH DVR recording 24 hours per day and the record stores for 30 days. The DVR adopts dual stream recording. The main stream is 4096Kbps and the sub stream is 1024Kbps, then the total recording capacity is 49.45TB (39.56TB + 9.89TB).

Considering the format loss of the disk is about 10%, the required disk capacity will be 55TB (49.45TB  $\div$  (1-10%)).

## Appendix C Compatible Device List

### Compatible HDD list

Brand and Series		Capacity
Seagate	Barracuda Series	500GB /1TB /2TB /3TB
	SV35 Series (recommended)	1TB /2TB /3TB
	Surveillance HDD Series (recommended)	1TB /2TB /3TB /4TB /6TB
Western Digital	Blue Series	500GB /1TB
	Green Series	2TB /3TB /4TB
	Purple Series (recommended)	1TB /2TB /3TB /4TB /6TB

### Compatible USB mobile device

Brand	Capacity
SSK	2GB
Netac	4GB
Kingston	2GB/8GB/16GB/32GB
Aigo	2GB
Smatter vider	1GB
SanDisk	4GB/8GB/16GB/32GB

**Sales** +44(0)1707 330541

**Enquiries** [sales@genieproducts.co.uk](mailto:sales@genieproducts.co.uk)

**Website** [www.genieproducts.co.uk](http://www.genieproducts.co.uk)

**genie**