

# IP67 and 15m IR 1080p Body Worn Camera with GPS

---

BWC-01



User Manual

Please read these instructions carefully before operating the unit and keep for further reference.

genie

1.0 Introduction.....	3
1.1 Product Features .....	3
1.2 Product Dimensions .....	3
1.3 Contents .....	3
1.4 Specification.....	4
2.0 Structure Design.....	5
2.1 Front View.....	5
2.1 Back View .....	6
3.0 Basic Operations.....	7
3.1 Live View Window.....	7
3.2 Main Menu .....	8
3.3 Video Resolution.....	8
3.4 Video Quality .....	9
3.5 Video Clip .....	9
3.6 Pre-Recording .....	9
3.7 Post Recording .....	9
3.8 Photo Pixel .....	9
3.9 Snapshot .....	9
3.10 LCD Brightness .....	9
3.11 Screen Off.....	9
3.12 Video Loop .....	9
3.13 Volume .....	9
3.14 Indicate sound .....	10
3.15 Key Sound.....	10
3.16 Hourly Notice.....	10
3.17 Indicate Light.....	10
3.18 Vibration .....	10
3.19 Laser Light .....	10
3.20 Auto IR Switch .....	10
3.21 GPS .....	10
3.22 Language .....	10
3.23 Auto Power Off.....	10
3.24 Microphone.....	11
3.25 Motion Detect.....	11
3.26 Security Password .....	11
3.27 IR Sensitive.....	11
3.28 Start Logo .....	11
3.29 Default Setting.....	11
4.0 Using The Device.....	12
4.1 Turning on the Camera.....	12
4.2 Turning off the Camera .....	12
4.3 Snapshot .....	12
4.4 One Touch Snapshot .....	12
4.5 Recording Video.....	12
4.6 One Touch Video Recording .....	12
4.7 Audio Recording .....	12
4.8 One Touch Audio Recording .....	12
4.9 IR Mode .....	12
4.10 White Light.....	12
4.11 Laser Light.....	13
4.12 Playback.....	13
4.13 Menu Configuration.....	13
4.13 Charging the Battery.....	13

## 1.0 Introduction

Please read this instruction carefully before operating the product and keep it for further reference. All examples and pictures used here are for reference only. The contents of this manual are subject to change without notice.

### 1.1 Product Features

- Full 1080p HD recording
- 120 ° wide angle
- Built-in GPS
- 4-6 hours continuous recording
- IP67 ingress protection
- 2" colour screen
- 32GB memory
- Supports external camera

### 1.2 Product Dimensions

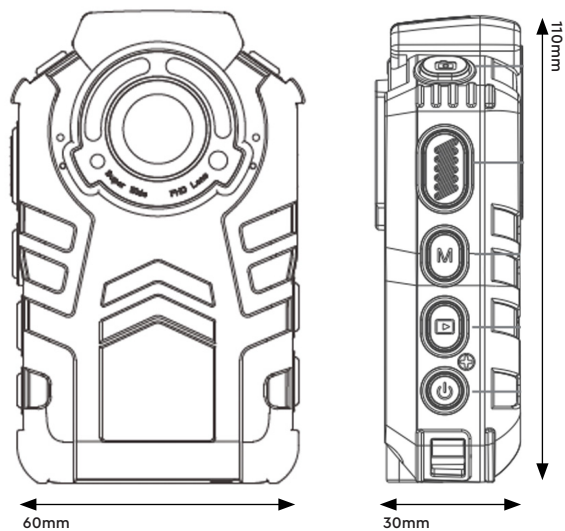

### 1.3 Contents

- Body worn camera
- USB cable
- USB power adapter
- CD with manual and software
- Universal metal clip

### 1.4 Specification

Camera	Focus Range	0.5m to infinity
	Digital Zoom	x16
	Video	2304×1296, 1920×1080, 1440×1080, 1280×720, 848×480 (MP4)
	Pre Recording	30s
	Post Recording	Up to 10 minutes
	Camera Snapshots	32 Megapixel 7600×4275 (JPEG Format)
	Lens Positioning	Laser light showing where the camera is aimed
	One Touch-Record	In power off mode. Press video button and starts video recording
	Audio	Yes
	Night Vision	Visible from 15m ways in pitch darkness
Others	Storage Capacity	32GB
	Display Screen	2.0 inches colour screen
	Light	LED lighting, support colour video recording during night
	Working Time	4-6 hours recording time
	Charging Time	5 hours
	Drop Resistance	More than 3m
	Ingress Protection	IP67
	Dimensions	110 × 60 × 30 mm
Weight	170g	

### 2.1 Front View

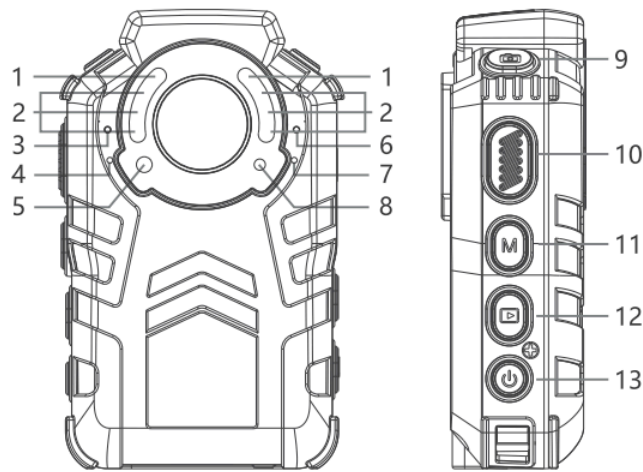

Item	Name	Description
1	Torch	Short press the power button to enable the Torch function for auxiliary lighting
2	IR light	For clear monochrome images in lowlight conditions. IR distance approx. 5m.
3	Charge indicator	Solid red means camera is charging, solid green means the charging is complete.
4	Recording Mic	High powered directional mic for audio recording.
5	Brightness sensor	The sensor will detect the brightness of the environment, and then activate the IR light and switch to night vision mode if the IR lights are set to auto setting.
6	Working indicator	Red blinking means video recording, yellow blinking means audio recording, solid green means standby or preview mode.
7	Intercom Mic	Capture audio when using the intercom.
8	Laser light	Pinpointing an object from a distance, solid or blinking mode
9	Snapshot button	Press this button to take a picture, can achieve multiple image captures when in burst mode.
10	PTT button	If the BWC is connected to external comms device, press this button to start talking.
11	Menu button	Press the button to enter into the configure menu to modify the parameters.
12	Playback button	Press the button to enter into the playback interface during the live view mode, review video, image and audio files.
13	ON/OFF button	Short press the button to open or close the lighting, long press it to power on or power off.

## 2.1 Back View

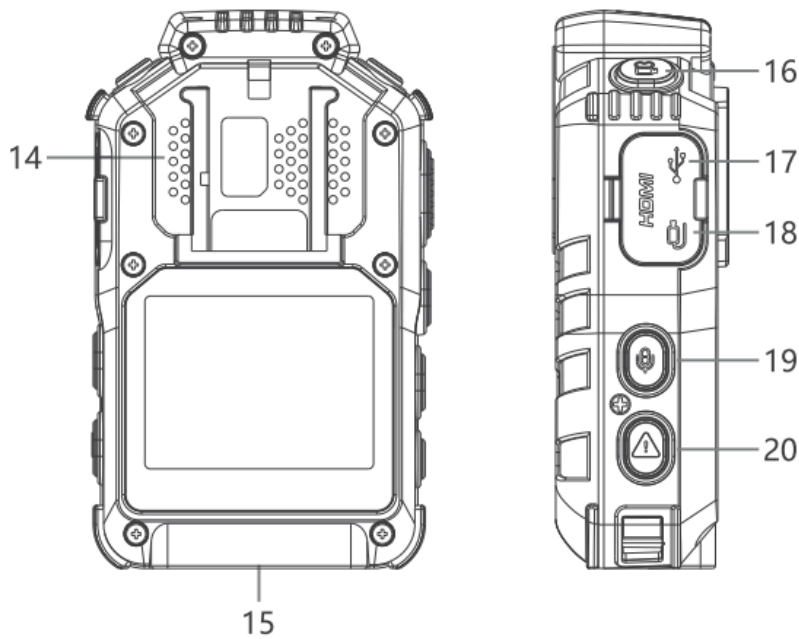

Item	Name	Description
14	Speaker	The speaker for playback and voice report
15	Data interface	The interface for docking, walkie-talkie and external battery connection
16	Video REC button	Press this button to start the video recording.
17	USB port	Connect USB cable for charging or connection to PC.
18	External camera port	Connects to external camera, when it is connected, the image will switch to external camera automatically.
19	Audio REC button	Press the button to start the audio recording only.
20	Flag button	During the video recording, press this button to tag this video file, this will then be flagged as important in the software.

## 3.0 Basic Operations





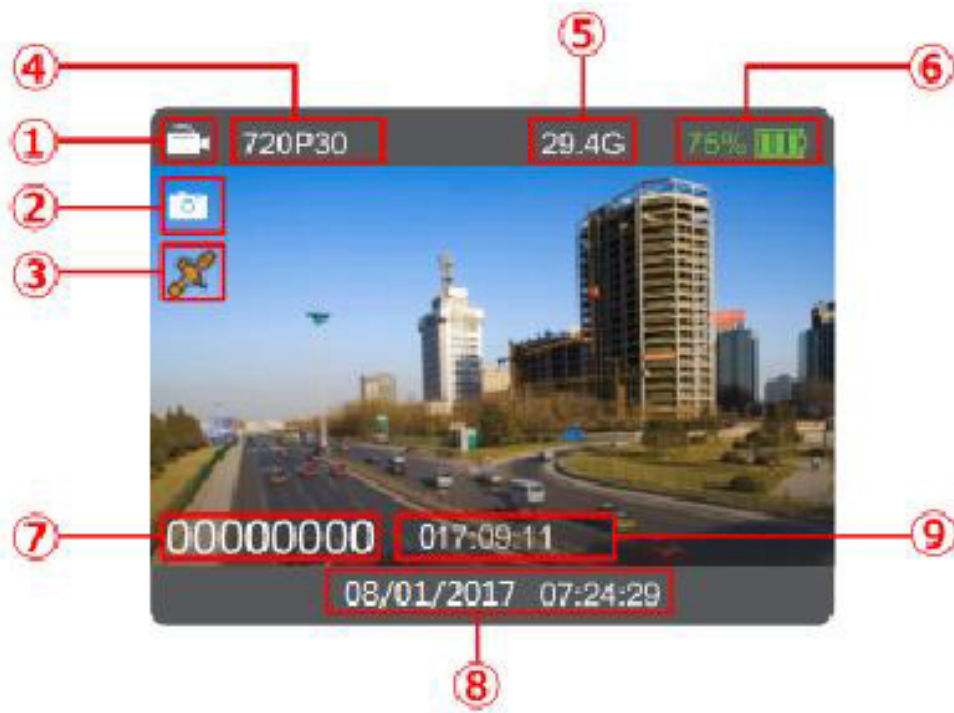

### 3.1 Live View Window

The body worn camera LCD screen is a small monitor to display various camera information and operation status.



Item	Name	Description
1	Video recording icon	Yellow means video recording is working
2	Snapshot icon	Yellow means snapshot is working
3	GPS icon	Yellow means GPS is detecting, green means GPS signal is valid.
4	Recording resolution	The current resolution that video recording is using
5	Storage size	The remaining storage capacity
6	Battery status	The current status of the battery
7	Officer ID number	The officer ID of this camera
8	Date/Time	The current date/time
9	The remaining recording remaining recording time	How long the video recording will work.

### 3.2 Main Menu

In preview mode, press menu button to enter into main menu interface, press  /  to select the option menu, and then press  to confirm the operation, and then press  /  to select the sub options, and then press  to active the option.

ID	Menu	Options
1	Video resolution	1080P30,1296P30,848P30,848P60,720P30,720P60,1440P30
2	Video quality	High,Low,Mediumw,Medium
3	Video clip	Auto,10min,20min,30min
4	Pre-recording	OFF,ON
5	Post-recording	5sec,10sec,30sec,1min,2min,5min,10min,OFF
6	Photo pixel	5M,8M,10M,12M,16M,21M,32M
7	Snapshot	2 PCS,3 PCS,5 PCS, 10 PCS,15 PCS,20 PCS2 PCS,3 PCS,5 PCS, 10 PCS,15 PCS,20 PCS
8	LCD brightness	1,2,3,4,5,6,7,8,9,10,9,10
9	Screen off	30sec,1min,3min,5min,OFF
10	Video loop	ON,OFF
11	Volume	0,1,2,3,4,5,6,7,8,9,10
12	Indicate sound	Beep,Mute,Voice
13	Key sound	ON,OFF
14	Hourly notice	ON,OFF
15	Indicate light	ON,OFF
16	Vibration	ON,OFF
17	Laser light	Auto,Manual,OFF,OFF
18	Auto IR switch	Auto,Manual,OFF
19	GPS	ON,OFF
20	Language	4 options
21	Auto power off	OFF,60min,30min,20min,10min
22	Microphone	ON,OFF
23	Motion detect	ON,OFF
24	Security password	ON,OFF
25	IR Sensitive	Low,Medium,High
26	Start logo	ON,OFF
27	Default setting	ON,OFF

### 3.3 Video Resolution

The body worn camera offers five different recording resolutions. Resolution and frame rate options feature a proper balance between video quality and maximizing amount of video stored.

Options	Display Resolution	Images per Second
720P30	1280×720	30
848P60	848×480	60
848P30	848×480	30
1296P30	2304×1296	30
1080P30	1920×1080	30
1440P30	1440×1080	30
720P60	1280×720	60



### **3.4 Video Quality**

Select video quality based on the need of video recording. High will give the best quality but will take up the most storage.

### **3.5 Video Clip**

Video clip selection defines the length of each video segment, and this option only is used for video recording, invalid for audio recording.

Sub-option: Auto, 10 minutes, 20 minutes, 30 minutes; auto means it will create a file up to 2GB in size, and the time will be around an hour.

### **3.6 Pre-Recording**

Pre-recording saves an additional seconds of video before the video recording button is pressed, and the additional seconds is about 30 seconds. After the option of pre-recording is enabled, the camera cannot take snapshots, but the snapshot will work during the video recording. Pre-recording will work to a maximum 1 minute 20 seconds.

### **3.7 Post Recording**

Post-recording means how long the camera should continue to record after the video recording button is pressed to stop recording.

### **3.8 Photo Pixel**

The photo pixel provides options for still image resolution.

### **3.9 Snapshot**

In preview mode, long press the snapshot button to shoot the selected number of pictures, And you can set the option as 2 PCS, 3 PCS, 5 PCS, 10 PCS, 15 PCS, 20 PCS. When video recording is working, the function will not work; when video recording is working, short press snapshot button can take one single photo.

### **3.10 LCD Brightness**

Adjust the LCD brightness to fit lighting situation for a clearer view of the screen. 10 is the highest level.

### **3.11 Screen Off**

If set to on, the screen will automatically power off even if the unit is recording, this will save battery consumption.

### **3.12 Video Loop**

When you create one new video recording file, if the file size is more than the remaining storage of camera, the camera will delete the most original file, so that the new file can be saved. Here if the video file is tagged as imp file, the imp file cannot be deleted.

### **3.13 Volume**

Select volume level option to increase or decrease all the volume of camera, including playback, key sound, indicate sound and so on.

### 3.14 Indicate sound

This option means when the user operates camera, it will give the corresponding response, OFF, beep or voice, and it will be applied to the operations as follows:

1. Start video recording;
2. Stop video recording;
3. Start audio recording;
4. Stop audio recording;
5. Power on the camera;
6. Power off the camera;
7. Low battery;
8. Inadequate storage space;

### 3.15 Key Sound

Select to turn the key tone ON or OFF when you press the button keys.

### 3.16 Hourly Notice

Select to turn the hourly notice ON or OFF, it will give the voice report hourly if the switch is ON.

### 3.17 Indicate Light

Select to turn all the LED ON or OFF, including the status LED and power LED.

### 3.18 Vibration

It will be used in the situations:

1. press the video recording button;
2. press the audio recording button;
3. Power off the camera;
4. Power on the camera.

It will remind the users that the function is in use.

### 3.19 Laser Light

The laser light can be activated in this option, auto means when the video recording starts, the laser light will blink 1 minute one time; For manual mode, long press the menu button to activate or inactivate it, and it is applied to two situations: 1. video recording is working; 2. it is in preview mode.

Remark: when it is in auto mode, you cannot press menu button to activate it.

### 3.20 Auto IR Switch

If the users choose manual mode, when the camera is using video recording or in preview mode,, long press M key to activate it or inactivate it.

If the users choose auto mode, during video recording (not preview mode), the IR will work when the environment is dark, similarly, when the environment is bright, the IR will be closed automatically.

*Note: when it is auto mode, we cannot press M key to activate it.*

### 3.21 GPS

Select to turn GPS function ON or OFF.

### 3.22 Language

The language will be applied to the screen display and all the voice notice, and the users can choose between 4 languages.

### 3.23 Auto Power Off

Turn off the camera after a certain time if there is any operation.

### **3.24 Microphone**

Select to turn the built

Select to turn the built-in microphone ON or OFF, when start audio recording, even in microphone ON or OFF, when start audio recording, even if the microphone is OFF, it will still be activated.

When microphone is OFF, video recording will not record any audio.

When microphone is OFF, video recording will not record any audio..

### **3.25 Motion Detect**

If there is something moving in the screen of preview mode, the video recording will be activated automatically, otherwise, the video recording will stop working automatically.

### **3.26 Security Password**

Select to turn security password ON or OFF.

When it is ON, it will require the password when the users go to playback mode and menu mode, the default password is 000000

### **3.27 IR Sensitive**

Gives the user the option to select how sensitive the IR switchover is if set to low the switchover from day to night mode will happen in lower light than if set to high.

### **3.28 Start Logo**

Select to turn the start logo ON or OFF, it means the logo picture will be shown when start up or shut down

### **3.29 Default Setting**

When it is set as ON, the camera will auto reboot to clear all the settings of menu, but all the playback files will still be in the camera.

## 4.0 Using The Device



### 4.1 Turning on the Camera

In power off status, long press  for 3 seconds, the camera will be turned on and enter into preview mode automatically. Meanwhile, the status indicator will turn green.

### 4.2 Turning off the Camera

In preview mode, long press  for 3 seconds, the camera will save the current status and power off. Meanwhile, the status indicator will turn off.

### 4.3 Snapshot

In preview mode, press  to take a photo; long press  to take more photos continuously, the quantity of photo can be configured in the menu. The image will be saved in JPEG format.

### 4.4 One Touch Snapshot



In power off status, long press  to turn on the camera and a photo will be taken. The status indicator will turn red and flash. The photo will be saved in JPEG format automatically.

### 4.5 Recording Video



In preview mode, short press  to start recording. Meanwhile, the status indicator will turn red and flash, and the recording icon will turn to yellow. Short press again to stop recording, and the video will be saved in MP4 format automatically.

*Note: During video recording, long press "Audio REC" button to mark the video as important video, press again to cancel it. And press "Snapshot" button to zoom in and zoom out.*



### 4.6 One Touch Video Recording

In power off status, long press  to turn on the camera and it will start recording. Meanwhile, the status indicator will turn red and flash, recording icon will turn to yellow. Press  again to stop recording, and the video will be saved in MP4 format automatically.



### 4.7 Audio Recording

In preview mode, press  to start audio recording. Meanwhile, the status indicator will turn to yellow and flash. Press  again, the camera will stop audio recording, and the audio will be saved in WAV format automatically.



### 4.8 One Touch Audio Recording

In powered off status, long press , the camera will be turned on and start audio recording. Meanwhile, the status indicator will turn yellow and flash. Press  again, the camera will stop audio recording, and the audio will be saved in WAV format automatically.



### 4.9 IR Mode

When the users set the IR as manual mode, in preview mode or during recording a video, long press  to switch to IR mode. Long press  again to exit from IR mode.

### 4.10 White Light





White light is used for auxiliary illumination when the brightness of environment is not good. In power on status, short press  to turn on the white light, and short press  again to turn it off.

#### 4.11 Laser Light

Manual mode: in preview mode or during recording a video, long press  button to turn on the laser light; long press  button again to turn it off.







Auto mode: During video recording status; it will turn on laser light to position automatically and turn off after one minute.

#### 4.12 Playback

In the preview mode, press  to enter into the playback interface. The move left icon is  and the move right is  press  to confirm your selection, press  button to exit, as the figure shown:

Left→ video  Right→ photo  OK→ playback  Exit→ button 

#### 4.13 Menu Configuration

In preview mode, press button to enter menu interface, press  /  to select the option, and then press  to confirm the operation, and then press  /  to select corresponding icon, and then press  to active the option.

#### 4.13 Charging the Battery

This camera has a chargeable battery built in. In case of low battery, please connect this camera to power supply for battery charging. Connect this camera and adaptor via USB cable, and connect adaptor to power supply to charge the battery. In charging status, the status indicator will turn red. Once the battery is fully charged, the status indicator will turn green.

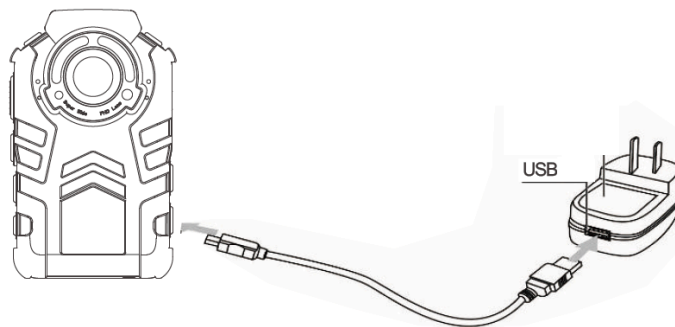

**Note:**

*When you recharge the body camera, please make sure it is OFF. Also, even you don't use the camera for a long time; please recharge it every 3 months.*

**Sales** +44(0)1707 330541

**Enquiries** [sales@genieproducts.co.uk](mailto:sales@genieproducts.co.uk)

**Website** [www.genieproducts.co.uk](http://www.genieproducts.co.uk)

**genie**