

# 5MP 4-in-1 AHD Starlight IR Eyeball Camera with 2.8–12mm Auto Focus Lens

---

WHD5EBVAF



User Manual

Please read these instructions carefully before operating the unit  
and keep for further reference.

genie

Please read this instruction carefully before operating the product and keep it for further reference. All examples and pictures used here are for reference only. The contents of this manual are subject to change without notice.

### **CAUTION:**

- If the product does not work properly, please contact your dealer or the nearest service centre. Never attempt to disassemble the camera yourself. We shall not be responsible for any problems caused by unauthorised repair or maintenance.
- Do not allow water or liquid into the camera while in use.
- When using the product, you must be in strict compliance with the electrical safety regulations of the nation and region.
- When the product is mounted on wall or ceiling, the device needs to be firmly fixed.
- Make sure the power supply voltage is correct before using the camera.
- Do not drop the camera or subject it to any physical shock.
- If cleaning, please use a clean soft cloth with a little neutral detergent to wipe it gently.
- Do not aim the camera at the sun or in any area where there is bright lighting.
- The device may be burned out by a laser beam, so when any laser equipment is in use, make sure that the surface of the device will not be exposed to the laser beam.
- Do not place the camera in extremely hot, cold , dusty or damp locations, and do not expose it to high electromagnetic radiation.
- To avoid heat accumulation, good ventilation is required for operating environment.

# Contents

---

1.0 Introduction.....	4
1.1 Product Features.....	4
1.2 Product Dimensions .....	4
1.3 Specification.....	5
1.4 Functions .....	6
2.0 Cables .....	7
3.0 Product Installation.....	8
4.0 Call Up Main Menu .....	9

## 1.0 Introduction

The Genie WHD5EBVAF is a professional, modern eyeball design CCTV camera with a "Starlight" sensor, offering amazing colour images in the lowest of lighting environments. It boasts 4-in-1 technology (AHD, TVI, CVI, CVBS) and utilises a superb 2.8mm to 12mm motorised auto focus lens. The camera offers IP67 protection and up to 50m viewing when the IR illumination is switched on.

### 1.1 Product Features

- 5MP @ 20fps / 4MP @ 30fps image, high resolution, true colour
- Switchable AHD, TVI, CVI, CVBS (960H) output
- CMOS progressive scan, improves moving object capture
- Supports OSD menu
- High speed, long distance and real time transmission
- Auto colour to B&W at low illumination
- Supports ICR switch, true day / night
- Supports noise reduction function
- 30 ~ 50m IR night view distance
- IP67 ingress protection

### 1.2 Product Dimensions

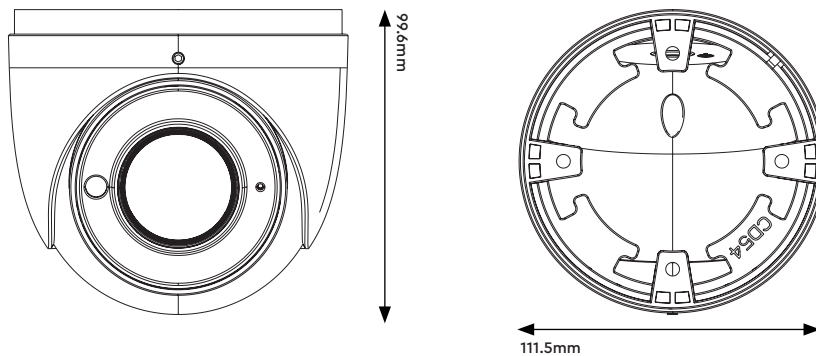

### 1.3 Specification

Camera	Image Sensor	1 / 2.7" CMOS
	Image Size	2560 × 1936
	Image System	PAL / NTSC
	Resolution	5MP
	Electronic Shutter	Auto
	Minimum Illumination	Colour : 0.001 Lux @ F1.2, AGC ON B&W : 0 Lux with IR
	Lens	2.8–12 mm motorised lens
	Lens Mount	D14
	S / N Ratio	≥52dB (AGC Off)
	Frame Rate	5MP @ 20fps
	Video Output	AHD / TVI / CVI / CVBS
Functions	IR Distance	30 ~ 50 m
	Function Control	OSD (COC Control)
	Day & Night	ICR
	Digital WDR	Yes
	Digital NR	Yes
	AGC	Yes
	Auto White Balance	Yes
	BLC	Yes
	LSC	Yes
	HLC	Yes
	Mirror	Yes
	Defog	No
	Sharpness	Yes
	Smart IR	Yes
	Image Setting	Yes
	Defect Correction	Auto
Language	13 languages	
Angle Adjustment	Pan: 0°~360°, Tilt: 0°~90°, Rotation: 0°~360°	
Others	Ingress Protection	IP67
	Power Supply	DC12V (± 10%)
	Power Consumption	IR Off : < 1W, IR On : < 6W
	Working Environment	- 30°C ~ 50°C, 10 % ~ 90 % (Relative Humidity)
	Dimensions	111.5 × 99.6 mm
	Weight	Approximately 0.54Kg (Net)

## 1.4 Functions

### High Resolution

Adopt high performance sensor, providing high definition and clear image.

### High Transmission Performance

Real-time transmission with high speed and long distance.

### DNR

Reduce noise from brightness and colour signal.

### OSD

It's easy for the user to call the setup menu and configure the menu. The camera settings can be clearly displayed through the main menu.

### White Balance

Adjust the colour temperature according to the environment automatically.

### ICR Auto Switch

The filter will filter infrared light during the daytime and change to normal at night to ensure a high sensitivity and clear image.

### AGC

Adjust the gain of amplifier, enabling the camera to output the standard video signal in different lighting condition.

### Wide Dynamic Range (WDR)

When there are both very bright and very dark areas simultaneously in the field of view, this function will balance the brightness level and provide clear images.

### Backlight Compensation (BLC)

When the back of the captured object is too much bright, you can set BLC for the captured object to make it clearer.

## 2.0 Cables

The cables are only for reference. The default video output will be different for different cameras.

For the camera with video switch cable, there are two kinds of video switches, button switch and dial switch.

Button Switch: The video outputs will recycle by holding and pressing the button in the video switch cable for 5 seconds.

Dial Switch: Please set the video output according to the directions described on the tag of the video switch cable.

**Note:**

*Before switching video outputs, remove the cover of the video switch cable first.*

*\* Some models do not have the video switch cable, please go to OSD to change video outputs.*

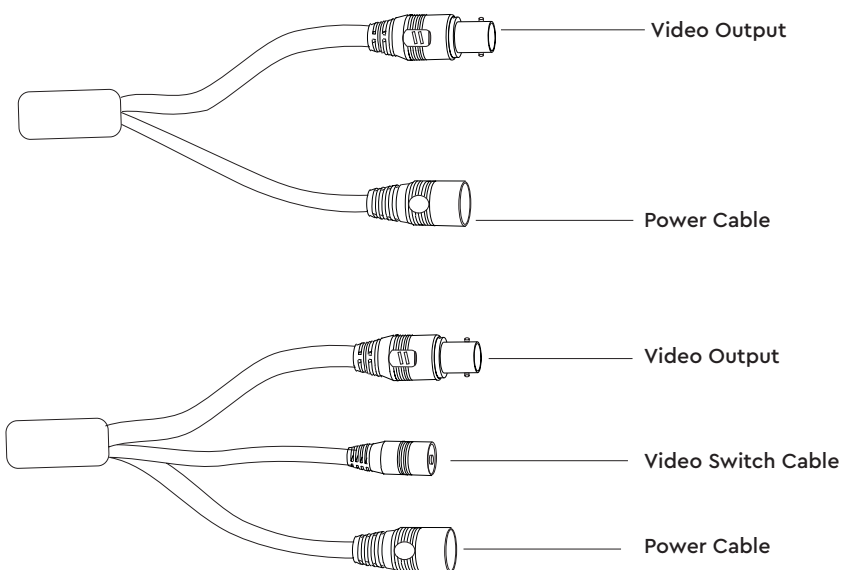

### 3.0 Product Installation

Before you start, please make sure that the wall or ceiling is strong enough to withstand 3x the weight of the camera. Please install the camera in the dry environment.

1. Attach the drill template to the place where you want to fix the camera and then drill screw holes according to the drill template.
2. Remove the mounting base of the camera.

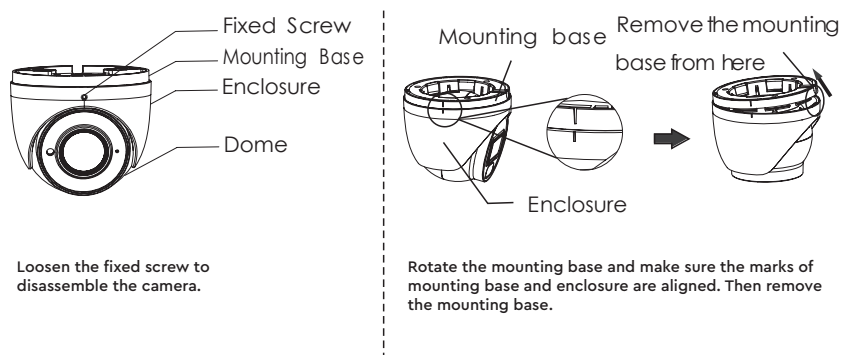

3. Route and connect the cables. Then secure the mounting base to the ceiling or wall with the screws provided.

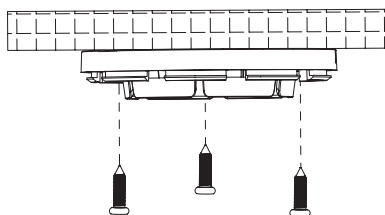

4. Install the dome and enclosure to the mounting base and then adjust the dome to obtain an optimum view angle.
5. Adjust the Focus and Zoom screw to get a clear image (if your camera is fixed lens or motorised lens, please skip this step).

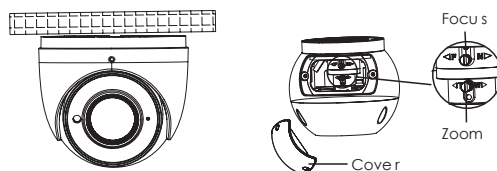



## 4.0 Call Up Main Menu

### Access Main Menu

1. Press Enter  key of the rear panel or cable of the camera to go to the main menu.
2. Select the preview window and right click the mouse to show the following menu list on the DVR.





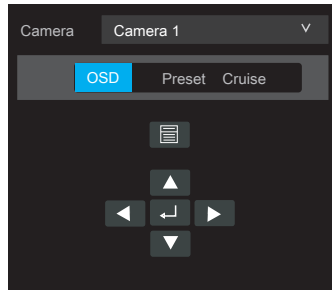



3. Click  on the toolbar at the bottom of the live preview window (or right click the mouse to select "PTZ Control").



4. Select the "OSD" tab and then click  /  to call up the main menu.

### Menu Operation

You can select the menu by clicking  (U) or  (D) key on the direction area. Click  (L) or  (R) key to select the menu on the left. The menu with arrow icon which means it has sub-menu. Click  /  to go to the sub-menu or confirm the settings.

If there are direction keys and enter key on the cables of the camera, you can also use these direction keys to select menu and the enter key to go to the sub-menu or confirm the settings.

*Note: This series of the camera must be connected to the DVR which supports calling up main menu of camera. Different DVRs manufactured by different DVR manufacturers may have different modes of menu operation. Please refer to the relevant User Manual of DVR.*

*\* Some models may not support calling up main menu, please take the final product as the standard.*

**Sales** +44(0)1707 330541

**Enquiries** [sales@genieproducts.co.uk](mailto:sales@genieproducts.co.uk)

**Website** [www.genieproducts.co.uk](http://www.genieproducts.co.uk)

**genie**